

SONY®

Sound Bar

Operating Instructions

WARNING

Do not install the appliance in a confined space, such as a bookcase or built-in cabinet.

To reduce the risk of fire, do not cover the ventilation opening of the appliance with newspapers, tablecloths, curtains, etc.

Do not expose the appliance to naked flame sources (for example, lighted candles).

To reduce the risk of fire or electric shock, do not expose this appliance to dripping or splashing, and do not place objects filled with liquids, such as vases, on the appliance.

The unit is not disconnected from the mains as long as it is connected to the AC outlet, even if the unit itself has been turned off.

As the main plug is used to disconnect the unit from the mains, connect the unit to an easily accessible AC outlet. Should you notice an abnormality in the unit, disconnect the main plug from the AC outlet immediately.

Do not expose batteries or appliances with battery-installed to excessive heat, such as sunshine and fire.

Indoor use only.

Recommended cables

Properly shielded and grounded cables and connectors must be used for connection to host computers and/or peripherals.

For the Bar Speaker

The nameplate is located on the bottom of the Bar Speaker.

For the customers in Europe

Notice for customers: the following information is only applicable to equipment sold in countries applying EU directives.

This product has been manufactured by or on behalf of Sony Corporation, 1-7-1 Konan Minato-ku Tokyo, 108-0075 Japan. Inquiries related to product compliance based on European Union legislation shall be addressed to the authorized representative, Sony Belgium, bijkantoor van Sony Europe Limited, Da Vincilaan 7-D1, 1935 Zaventem, Belgium. For any service or guarantee matters, please refer to the addresses provided in the separate service or guarantee documents.



Hereby, Sony Corp., declares that this equipment is in compliance with the essential requirements and other relevant provisions of Directive 1999/5/EC.

For details, please access the following URL:

<http://www.compliance.sony.de/>

This product is intended to be used in the following countries.

AT, BE, BG, HR, CY, CZ, DK, EE, FI, FR, DE, GR, HU, IS, IE, IT, LV, LI, LT, LU, MT, NL, NO, PL, PT, RO, SK, SI, ES, SE, CH, GB, AL, BA, MK, MD, RS, ME, TR, Kosovo

5150-5350 MHz band is restricted to indoor operations only.

This equipment has been tested and found to comply with the limits set out in the EMC regulation using a connection cable shorter than 3 meters.



**Disposal of Old
Electrical &
Electronic
Equipment
(Applicable in the
European Union
and other
European
countries with
separate collection systems)**

This symbol on the product or on its packaging indicates that this product shall not be treated as household waste. Instead it shall be handed over to the applicable collection point for the recycling of electrical and electronic equipment. By ensuring this product is disposed of correctly, you will help prevent potential negative consequences for the environment and human health, which could otherwise be caused by inappropriate waste handling of this product. The recycling of materials will help to conserve natural resources. For more detailed information about recycling of this product, please contact your local Civic Office, your household waste disposal service or the shop where you purchased the product.

Europe Only



Pb

**Disposal of waste
batteries (applicable
in the European Union
and other European
countries with
separate collection
systems)**

This symbol on the battery or on the packaging indicates that the battery provided with this product shall not be treated as household waste.

On certain batteries this symbol might be used in combination with a chemical symbol. The chemical symbols for mercury (Hg) or lead (Pb) are added if

the battery contains more than 0.0005% mercury or 0.004% lead.

By ensuring these batteries are disposed of correctly, you will help prevent potentially negative consequences for the environment and human health which could otherwise be caused by inappropriate waste handling of the battery. The recycling of the materials will help to conserve natural resources.

In case of products that for safety, performance or data integrity reasons require a permanent connection with an incorporated battery, this battery should be replaced by qualified service staff only.

To ensure that the battery will be treated properly, hand over the product at end-of-life to the applicable collection point for the recycling of electrical and electronic equipment. For all other batteries, please view the section on how to remove the battery from the product safely. Hand the battery over to the applicable collection point for the recycling of waste batteries.

For more detailed information about recycling of this product or battery, please contact your local Civic Office, your household waste disposal service or the shop where you purchased the product.

Table of Contents

Supplied Accessories	6
Guide to Parts and Controls	7
About the Home Menu	12

Connecting and Preparation

Basic connections and preparation	➔	Startup Guide (separate document)
Connection for Viewing Copyright-protected 4K Content	15	
Mounting the Unit on a Wall	17	
Connecting to a Wired Network	18	
Connecting to a Wireless Network	20	

Listening to the Sound

Listening to the TV	22
Listening to the Connected Device	22
Listening to Music on a USB Device	23

Selecting the Sound Effect

Setting the Sound Effect that is Tailored to Sound Sources (SOUND FIELD)	25
Enjoying Clear Sound with Low Volume at Midnight (NIGHT)	26
Making Dialogues Clearer (VOICE)	26
Adjusting the Volume of the Subwoofer	27
Adjusting the Delay Between the Picture and Sound	27

Listening to Music/Sound with the BLUETOOTH Function

Listening to Music from a Mobile Device	29
Listening to Sound of the Connected TV or Device from Headphones or Speakers	32

Enjoying with the Network Function

Listening to Music on your PC via a Home Network	34
Listening to Music on Music Services	35
Listening to Music on the Mobile Device with SongPal	36
Using Google Cast	37
Listening to Music by Connecting the SongPal Link-Compatible Device	37
Displaying the Screen of the Mobile Device on a TV (MIRRORING)	39

Using the Various Functions/Settings

Performing the Wireless Connection of the Subwoofer (LINK)	40
Playing Compressed Audio Files with Natural Sound Quality	41
Enjoying Multiplex Broadcast Sound (AUDIO)	41
Deactivating Buttons on the Unit	42
Changing the Brightness of the Front Panel Display and BLUETOOTH Indicator (DIMMER)	42
Saving Power in Standby Mode	43

Using the Control for HDMI Function	44
Using the "BRAVIA" Sync Function	46
Using the Setup Display	48
Options Menu List	56
Troubleshooting	
Troubleshooting	57
Resetting the System	64
Additional Information	
Specifications	65
Playable Types of Files	67
Supported Input Audio Formats	68
Supported Input Video Formats	69
On BLUETOOTH Communication	70
END USER LICENSE AGREEMENT	71
Precautions	75
Index	79

Supplied Accessories

- Bar Speaker (1)

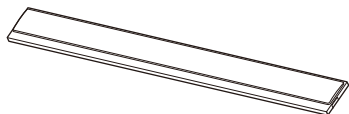

- Wall mounting brackets (2), Screws (2)



- Subwoofer (1)

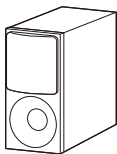

- Remote control (1)

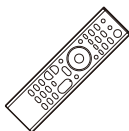

- R03 (size AAA) batteries (2)



- Optical digital cable (1)

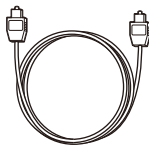

- Startup Guide (1)



- Operating Instructions (1)



Guide to Parts and Controls

Details are omitted from the illustrations.

Unit (Bar Speaker)

Front

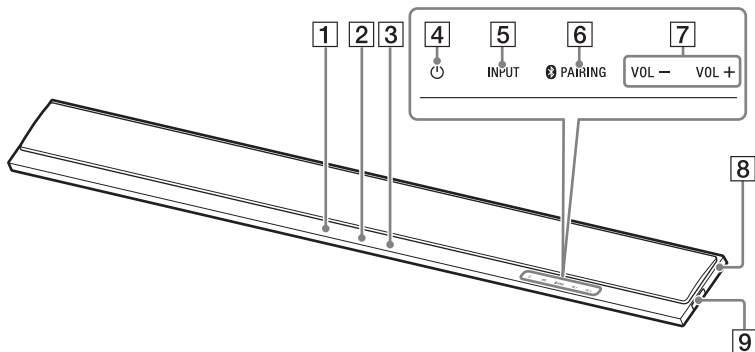

1 Remote control sensor

2 Front panel display

3 BLUETOOTH indicator (blue)

- Flashes quickly in blue: During pairing standby status
- Flashes in blue: BLUETOOTH connection is being attempted
- Lights in blue: BLUETOOTH connection has been established

4  (power) button

Turns on the system or sets it to standby mode.

5 INPUT button (page 12, 22)

6 PAIRING button (page 29)

7 VOL +/- buttons

8 N-Mark (page 30)

When using the NFC function, touch your NFC-compatible device to the mark.

9  (USB) port

Rear

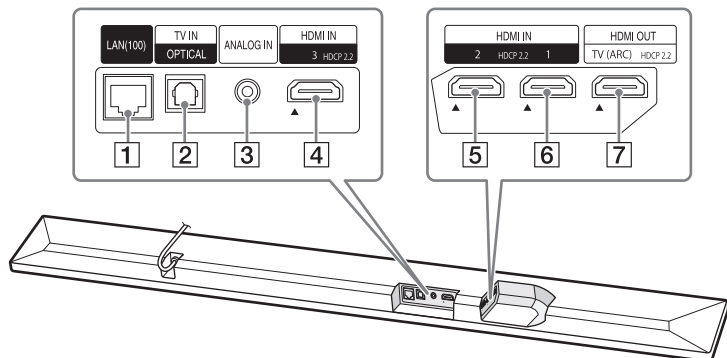

- 1** LAN(100) port
- 2** TV IN (OPTICAL) jack
- 3** ANALOG IN jack
- 4** HDMI IN 3 jack
Compatible with HDCP 2.2.
- 5** HDMI IN 2 jack
Compatible with HDCP 2.2.
- 6** HDMI IN 1 jack
Compatible with HDCP 2.2.
- 7** HDMI OUT (TV (ARC)) jack
Compatible with HDCP 2.2.

Subwoofer

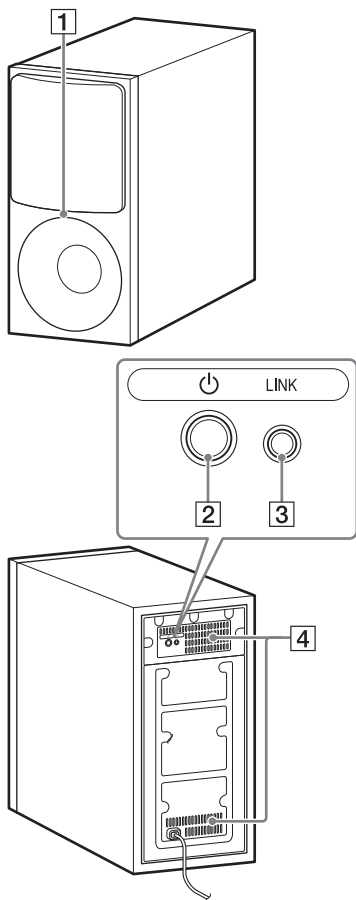

1 Power indicator

- Lights in red: The subwoofer is in standby mode
- Flashes in green: While attempting link connection
- Lights in green: The subwoofer is connected to the system with the link function

2 (power) button

Turns on the subwoofer or sets it to standby mode.

3 LINK button (page 40)

4 Ventilation holes

For safety, do not block the ventilation holes.

Remote Control

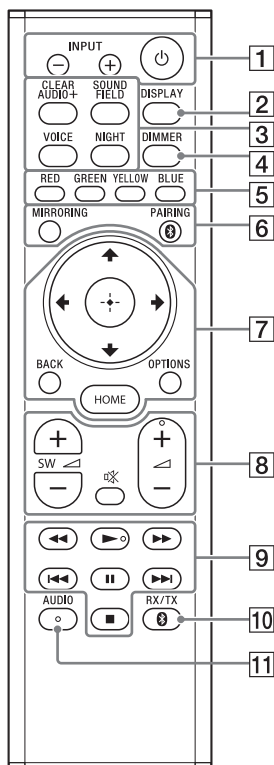

- 1 INPUT +/- (page 12, 22)**
⏻ (power)
Turns on the system or sets it to standby mode.
- 2 DISPLAY**
Displays playback information on the TV screen.
- 3 CLEAR AUDIO+ (page 25)**
SOUND FIELD (page 25)
VOICE (page 26)
NIGHT (page 26)
- 4 DIMMER (page 42)**
- 5 Color buttons**
Shortcut keys for selecting items on some menus.
- 6 MIRRORING (page 39)**
PAIRING (page 29)
- 7 OPTIONS (page 27, 56)**
BACK (page 12)
↑/↓/←/→ (page 12)
+ (enter) (page 12)
HOME (page 12)
- 8 ⏻ (muting)**
Turns off the sound temporarily.
↙ (volume) +/-
Adjusts the volume.
SW ↙ (subwoofer volume) +/-
Adjusts the volume of the subwoofer.

9 Playback operation buttons

◀◀/▶▶ (rewind/fast forward)

Searches backward or forward.

I◀◀/▶▶I (previous/next)

Selects the previous/next chapter, track, or file.

▶ (play)

Starts or re-starts playback (resume play).

|| (pause)

Pauses or re-starts playback.

■ (stop)

Stops playback.

**10 RX/TX (receiver/transmitter)
(page 33)**

11 AUDIO (page 41)

About the Home Menu

You can display the home menu on the TV screen by connecting the system and TV with the HDMI cable (not supplied). From the home menu, you can set the various settings by selecting  [Setup] or select the input or service that you want to watch from the input list.



Using the Home Menu

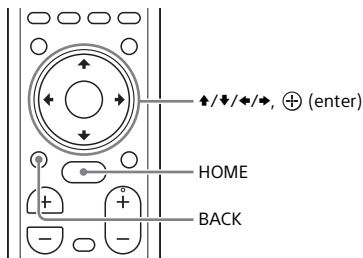

- 1 Press HOME.**
The home menu appears on the TV screen.
- 2 Press ▲/▼/◀/▶ to select  [Setup] or an item on the input list, then press ⊕.**
The selected input or setup display appears on the TV screen.
To return to the previous screen, press BACK.

Input list

Input name	Explanation
[TV]	Outputs the TV sound. (page 22)
[HDMI1]	Outputs the sound of device that is connected to the HDMI IN 1 jack. (page 22)
[HDMI2]	Outputs the sound of device that is connected to the HDMI IN 2 jack. (page 22)
[HDMI3]	Outputs the sound of device that is connected to the HDMI IN 3 jack. (page 22)
[Bluetooth Audio]	Outputs the sound of device that is connected with the BLUETOOTH function. (page 29)
[Analog]	Outputs the sound of device that is connected to the ANALOG IN jack.
[USB]	Outputs music or plays back photo files stored on a connected USB device. (page 23)
[Screen mirroring]	Displays the screen of the mobile device on the TV screen. (page 39)
[Home Network]	Outputs music or plays back photo files on the device that is connected via the network. (page 34)
[Music Services]	Uses music services on the Internet. (page 35)



[Setup]





See “Using the Setup Display” (page 48).

Tip





You can also select the input by pressing INPUT +/- repeatedly.

About the Steps Description





In these Operating Instructions, the operations are described as steps that are operated on the home menu displayed on the TV screen by using the remote control while the system and TV are connected with the HDMI cable (not supplied).

The operating steps that select items on the TV screen by using  and  are simplified in the following way.

Example: Select [Setup] from the home menu.

The operation that selects an item by pressing  and  is expressed as "select."

Example: Select [Network Settings] - [Internet Settings] - [Wired Setup] on the home menu.

When repeating the operation that selects an item by pressing  and , the selected items are linked with "-."

Tips

- You can use the buttons on the unit if they have the same or similar names as those on the remote control.
- Characters in brackets [] appear on the TV screen. Characters in quotes " " appear in the front panel display.

Connecting and Preparation

Connection for Viewing Copyright-protected 4K Content

Connecting a 4K TV and 4K Device

To view copyright-protected 4K content and listen to sound from the system, connect the TV and device to the system via an HDCP2.2-compatible HDMI jack. You can only view copyright-protected 4K content through the HDCP2.2-compatible HDMI jack connection.

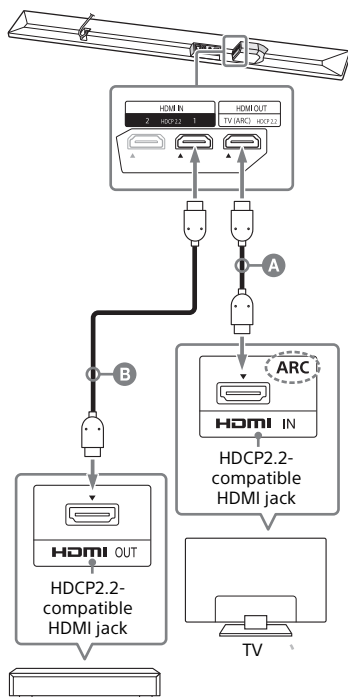

Blu-ray Disc™ player, cable box, or satellite box, etc.

- A** HDMI cable (not supplied)
- B** HDMI cable (not supplied)
Premium High Speed HDMI cable with Ethernet is recommended.

- 1** Check which HDMI input jack on your TV is compatible with HDCP2.2.
Refer to the operating instructions of the TV.
- 2** Connect the HDCP2.2-compatible HDMI input jack on the TV and HDMI OUT jack on the unit with the HDMI cable (not supplied).
TV connection is completed.

- 3** Connect the HDCP2.2-compatible HDMI output jack of the 4K device and HDMI IN jack of the unit with the HDMI cable (not supplied).

Refer to the operating instructions of the 4K device to check that the HDMI OUT jack of the 4K device is compatible with HDCP2.2. 4K device connection is completed.

- 4** Play copyright-protected 4K content.

The image appears on the TV screen and the sound is output from the system.

Tip

You can connect the 4K device to any of HDMI IN 1, HDMI IN 2, or HDMI IN 3 jack because all jacks are compatible with HDCP2.2.

When the TV's HDMI Jack is not Labeled with ARC

If your TV's HDCP2.2-compatible HDMI IN jack is not compatible with ARC, the TV sound is not output from the system. In this case, connect the optical output jack of the TV and the TV IN (OPTICAL) jack on the unit with the optical digital cable (supplied).

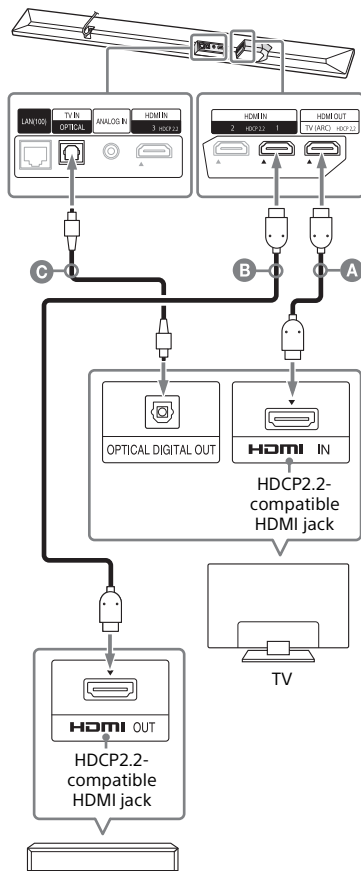

Blu-ray Disc player, cable box, or satellite box, etc.

- A** HDMI cable (not supplied)
- B** HDMI cable (not supplied)
Premium High Speed HDMI cable with Ethernet is recommended.
- C** Optical digital cable (supplied)

Mounting the Unit on a Wall

You can mount the unit on a wall.

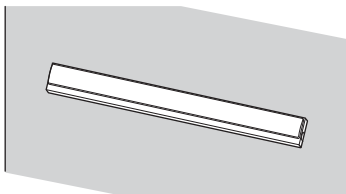

Notes

- Prepare screws (not supplied) that are suitable for the wall material and strength. As a plasterboard wall is especially fragile, attach the screws securely in the wall beam. Install the speakers horizontally, hung by screws in studs in a continuous flat section of the wall.
- Have the installation done by a Sony dealer or licensed contractor and pay special attention to safety during the installation.
- Sony shall not be held responsible for accidents or damage caused by improper installation, insufficient wall strength, improper screw installation or natural disaster, etc.

- 1 Fix the wall mounting brackets (supplied) to the bracket fixing holes on the bottom of the unit with the screws (supplied) so that the surface of each wall mounting bracket is as shown in the illustration.

Fix the two wall mounting brackets to the left and right fixing holes on the bottom of the unit.

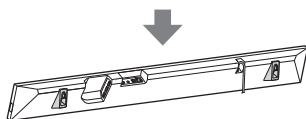
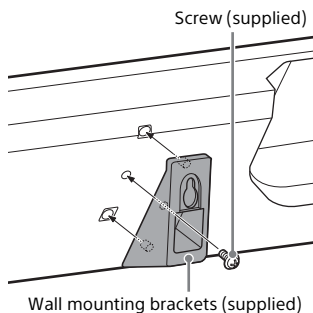

- 2 Prepare screws (not supplied) that are suitable for the holes on the wall mounting bracket.

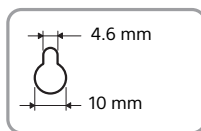
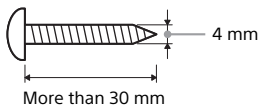

Hole on the wall mounting bracket

- 3 Fasten the screws in the wall.**
The screw should protrude as illustration.

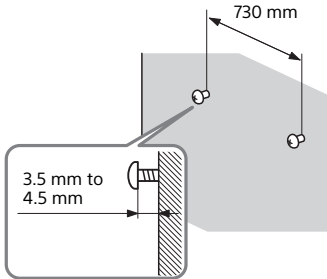

- 4 Hang the holes of the mounting bracket on the screws.**
Align the holes at of the mounting bracket with the screws, then hang the unit on the two screws.

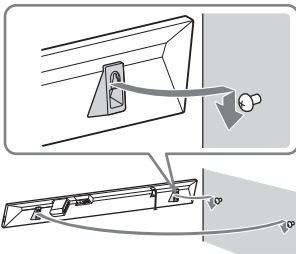

Connecting to a Wired Network

Prepare the network by connecting the system and PC to your home network with a LAN cable.

Connecting to a PC or Router with a LAN Cable

The following illustration is the example for connection of the system and PC to your home network.

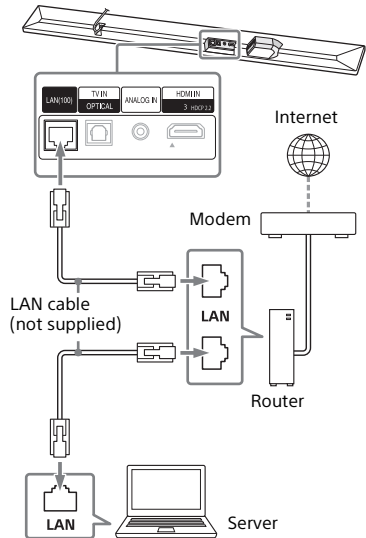

Note

The server needs to be connected to the same network as that of the system.

Tip



We recommend that you use a shielded straight interface cable (not supplied).

Connecting by Obtaining the Network Information Automatically

- 1 Press HOME.**

The home menu appears on the TV screen.
- 2 Select  [Setup] from the home menu.**

The setup display appears on the TV screen.
- 3 Select [Network Settings] - [Internet Settings] - [Wired Setup].**
- 4 Select [Auto].**

The system starts network settings and the network setting status appears.
Press / to browse information, and then press .
- 5 Select [Save & Connect].**

The system starts connecting to the network. For details, refer to the messages that appear on the TV screen.

Connecting by Using a Fixed IP Address



- 1 Press HOME.**

The home menu appears on the TV screen.
- 2 Select  [Setup] from the home menu.**

The setup display appears on the TV screen.
- 3 Select [Network Settings] - [Internet Settings] - [Wired Setup].**
- 4 Select [Manual].**

- 5 Perform the setting by following the on-screen instructions.**

The system starts network settings and the network setting status appears.

Press / to browse information, and then press .

- 6 Select [Save & Connect].**

The system starts connecting to the network. For details, refer to the messages that appear on the TV screen.

Connecting to a Wireless Network

Prepare the network by connecting the system and PC to your wireless LAN router.

Note

The server needs to be connected to the same network as that of the system.

Connecting with the WPS Button

When your wireless LAN router (access point) is Wi-Fi Protected Setup (WPS)-compatible, you can easily set the network settings with the WPS button.

- 1 Press HOME.**
The home menu appears on the TV screen.
- 2 Select  [Setup] from the home menu.**
The setup display appears on the TV screen.
- 3 Select [Network Settings] - [Internet Settings] - [Wireless Setup] - [Wi-Fi Protected Setup™ (WPS)].**
- 4 Select [Start].**
- 5 Press the WPS button on the access point.**
The system starts connecting to the network.

Connecting by Selecting the Network Name (SSID)

If your wireless LAN router (access point) is not compatible with Wi-Fi Protected Setup (WPS), check the following information in advance.

– The network name (SSID)*

– The security key (password)**

* SSID (Service Set Identifier) is a name that identifies a particular access point.

**This information should be available from a label on your wireless LAN router/access point, from the operating instructions, from the person who set up your wireless network, or from the information provided by your Internet service provider.

- 1 Press HOME.**
The home menu appears on the TV screen.
- 2 Select  [Setup] from the home menu.**
The setup display appears on the TV screen.
- 3 Select [Network Settings] - [Internet Settings] - [Wireless Setup].**
The list of the network name appears on the TV screen.
- 4 Select the desired network name (SSID).**
- 5 Enter the security key (or passphrase) using the software keyboard, and then select [Enter].**
The system starts connecting to the network.

Connecting by Using a Fixed IP Address

Select [New connection registration] - [Manual registration] in step 4 of "Connecting by Selecting the Network Name (SSID)" and follow the on-screen instructions.

Connecting by Using a PIN Code

Select [New connection registration] in step 4 of "Connecting by Selecting the Network Name (SSID)" and select [(WPS) PIN Method].

Connecting by SongPal

SongPal app can connect the system to the same wireless network as that of the mobile device. For details, follow the instruction of the app or refer to the following URL.

<http://info.songpal.sony.net/help/>

Listening to the TV

- 1 Press HOME.**

The home menu appears on the TV screen.
- 2 Select [TV] on the home menu.**
- 3 Select the program using the TV's remote control.**

The selected TV program appears on the TV screen and the TV sound is output from the system.
- 4 Adjust the volume.**
 - Adjust the volume by pressing \triangleleft +/- on the remote control.
 - Adjust the subwoofer volume by pressing SW \triangleleft +/- on the remote control (page 27).

Tip

You can select [TV] by pressing INPUT +/- on the remote control.

Listening to the Connected Device

- 1 Press HOME.**

The home menu appears on the TV screen.
- 2 Select the input that the desired device is connected on the home menu.**

The image of the selected device appears on the TV screen and the sound is output from the system. If you select [Analog], the home menu is displayed on the TV screen.
- 3 Adjust the volume.**
 - Adjust the volume by pressing \triangleleft +/- on the remote control.
 - Adjust the subwoofer volume by pressing SW \triangleleft +/- on the remote control (page 27).

Tip

You can select the input by pressing INPUT +/- on the remote control.

Changing the Input Name Displayed on the Home Menu

You can change the input name of [HDMI1], [HDMI2], or [HDMI3] that is displayed on the home menu.

- 1 Press HOME.**

The home menu appears on the TV screen.
- 2 Put the cursor on [HDMI1], [HDMI2], or [HDMI3] on the home menu, then press OPTION.**

The options menu appears on the TV screen.
- 3 Select [Input Label].**

4 Select the input name.

You can select the input name from the following.

- [BD Player]
- [DVD Player]
- [Cable Box]
- [Satellite]
- [GAME]
- [PC]

5 Press \oplus to complete.**Tip**

When you change the input name, the displayed icon is also changed automatically.

Listening to Music on a USB Device

You can play music/photo files stored on a connected USB device.

For playable types of files, see "Playable Types of Files" (page 67).

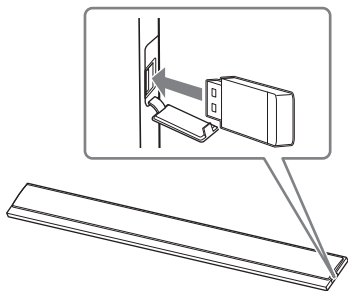
1 Connect the USB device to the USB (USB) port.**2 Press HOME.**

The home menu appears on the TV screen.

3 Select [USB (Connected)] from the home menu.**4 Select [Music] - folder on which songs are stored - song.**

The selected song is played and sound is output from the system.

5 Adjust the volume.

- Adjust the volume by pressing \triangleleft +/- on the remote control.
- Adjust the subwoofer volume by pressing SW \triangleleft +/- on the remote control (page 27).

Note

Do not remove the USB device during operation. To avoid data corruption or damage to the USB device, turn the system

off before connecting or removing the USB device.

Tip

You can perform various operations from the options menu (page 56).

Viewing Photos on a USB Device

You can play photo files stored on a connected USB device.

For playable types of files, see “Playable Types of Files” (page 67).

Select [Photo] - folder on which photos are stored - photo in step 4.

The selected photo appears on the TV screen.

Tip

You can perform various operations from the options menu (page 56).

Selecting the Sound Effect

Setting the Sound Effect that is Tailored to Sound Sources (SOUND FIELD)

You can easily enjoy pre-programmed sound effects that are tailored to different kinds of sound sources.

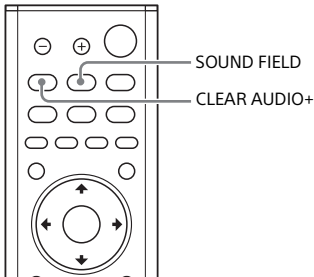

1 Press SOUND FIELD.

The sound field menu appears on the TV screen.

2 Press the button repeatedly to select the desired sound field.

Sound field	Explanation
[ClearAudio+]	The appropriate sound setting is automatically selected for the sound source.
[Movie]	Sound effects are optimized for movies. This mode replicates the density and rich expanse of sound.
[Music]	Sound effects are optimized for music.

Sound field	Explanation
[Sports]	Commentary is clear, cheers are heard as surround sound, and sounds are realistic.
[Game Studio]	Sound effects are optimized for game play.
[Standard]	Sound effects are optimized for the individual source.

Tips

- You can select [ClearAudio+] by pressing CLEAR AUDIO+ on the remote control.
- You can select the sound field from the options menu (page 56).

Enjoying Clear Sound with Low Volume at Midnight (NIGHT)

Sound is output at low volume with minimum loss of fidelity and clarity of dialogue.

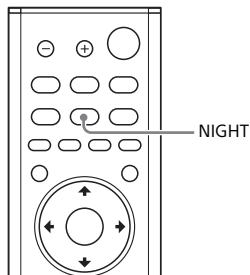

- 1 Press NIGHT.**
The night mode appears on the TV screen.
- 2 Press the button repeatedly to select the night mode.**

Mode	Explanation
[On]	Activates the night mode function.
[Off]	Deactivates the night mode function.

Tip
You can select [Night] from the options menu (page 56).

Making Dialogues Clearer (VOICE)

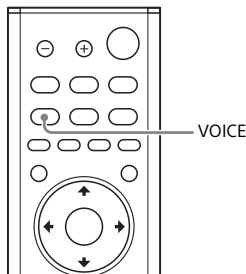

- 1 Press VOICE.**
The voice mode appears on the TV screen.
- 2 Press the button repeatedly to select the voice mode.**

Mode	Explanation
[Up Off]	Standard
[Up 1]	Dialogue is easily heard by enhancing dialogue range.
[Up 2]	Dialogue range is enhanced, and dialogue sound may be easy to hear for the elderly.

Tip
You can select [Voice] from the options menu (page 56).

Adjusting the Volume of the Subwoofer

The subwoofer is designed for playback of bass or low frequency sound.

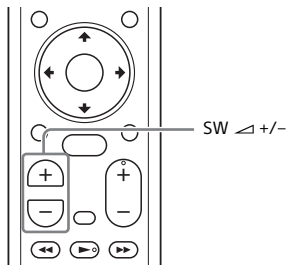

Press **SW (subwoofer volume) ▲ +/-** to adjust the volume of the subwoofer.

Note

When the input source does not contain much bass sound, such as in TV programs, the bass sound from the subwoofer may be difficult to hear.

Adjusting the Delay Between the Picture and Sound

When the sound does not match the pictures on the TV screen, you can adjust the delay between the picture and sound.

The setting method differs depending on the input.

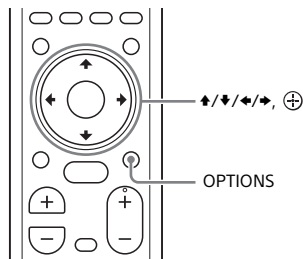

When Watching the TV

- 1 Press OPTIONS.**
"SYNC" appears in the front panel display.
- 2 Press ▶ or ⊕**
The adjusting time appears in the front panel display.
- 3 Adjust the delay using ▲/▼, then press ⊕.**
You can adjust from 0 msec to 300 msec in 25 msec increments.
- 4 Press OPTIONS.**
The options menu in the front panel display turns off.

When Watching Another Device

- 1 Press OPTIONS.**
The options menu appears on the TV screen.
- 2 Select [A/V SYNC].**
- 3 Adjust the delay using ◀/▶, then press ⊕.**
You can adjust from 0 msec to 300 msec in 25 msec increments.

Listening to Music/Sound with the BLUETOOTH Function

Listening to Music from a Mobile Device

You can listen to music stored on a mobile device such as a smartphone or tablet via a wireless connection by connecting the system and the mobile device with the BLUETOOTH function. When connecting to the mobile device with the BLUETOOTH function, you can operate by simply using the supplied remote control without turning the TV on.

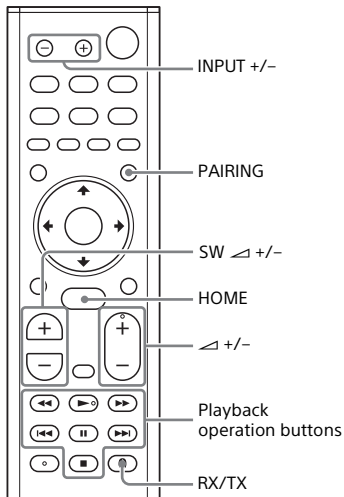

Listening to Music by Pairing with a Mobile Device

1 Press PAIRING.

The system enters the pairing mode, "BT" appears in the front panel display, and the BLUETOOTH indicator flashes quickly.

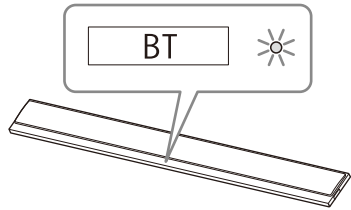

2 Turn on the BLUETOOTH function, and then select "HT-CT790" after searching for it on the mobile device.

If a Passkey is requested, enter "0000."

3 Make sure that the BLUETOOTH indicator on the unit lights in blue.

A connection between the system and mobile device has been established.

4 Start audio playback with the music app on the connected mobile device.

Sound is output from the unit.

5 Adjust the volume.

- Adjust the volume by pressing \triangle +/- on the remote control.
- Adjust the subwoofer volume by pressing SW \triangle +/- on the remote control (page 27).
- You can play or pause the content by using the playback operation buttons on the remote control.

To check the connection status of the BLUETOOTH function

Status	BLUETOOTH indicator
During pairing standby status	Flashes quickly in blue
Connection is being attempted	Flashes in blue
Connection has been established	Lights in blue
Not connected	Off

Tips

- Once the BLUETOOTH connection is established, an indication recommending which application to download will be displayed according to what device you have connected. Following the instructions displayed, an application called SongPal, which will enable you to operate this system, can be downloaded. Refer to "Listening to Music on the Mobile Device with SongPal" (page 36) for details on SongPal.
- Perform pairing for the second and subsequent mobile devices.
- To cancel pairing, press HOME.

Listening to Music from the Paired Mobile Device

1 Turn the BLUETOOTH function of the mobile device to on.

2 Press INPUT +/- repeatedly to display "BT" in the front panel display.

The input changes to [Bluetooth Audio] automatically, then the system automatically reconnects to the mobile device it was most recently connected to.

3 Make sure that the BLUETOOTH indicator lights in blue.

A connection between the system and mobile device has been established.

4 Start audio playback with the music app on the connected mobile device.

Sound is output from the unit.

5 Adjust the volume.

- Adjust the volume by pressing \triangleleft +/- on the remote control.
- Adjust the subwoofer volume by pressing SW \triangleleft +/- on the remote control (page 27).
- You can play or pause the content by using the playback operation buttons on the remote control.

To disconnect the mobile device

Perform any of the following items.

- Disable the BLUETOOTH function on the mobile device.
- Press PAIRING on the remote control.
- Turn off the system or mobile device.

Note

If "BT" does not appear in the front panel display by pressing INPUT +/- in step 2 of "Listening to Music from the Paired Mobile Device," press RX/TX on the remote control once.

Tip

When the connection is not established, select "HT-CT790" on the mobile device.

Connecting to a Mobile Device by One-Touch Function (NFC)

By holding an NFC-compatible mobile device such as a smartphone or tablet near the N mark on the unit, the system is turned on automatically, then pairing

and BLUETOOTH connection are performed automatically.

Compatible devices

Smartphones, tablets, and music players with the NFC function built-in (OS: Android™ 2.3.3 or later, excluding Android 3.x)

1 Turn on the NFC function of the mobile device.

2 Touch the N mark on the unit with the mobile device.

Keep touching until the mobile device vibrates and message appears on the mobile device. Follow the on-screen instructions to complete pairing of the unit and mobile device.

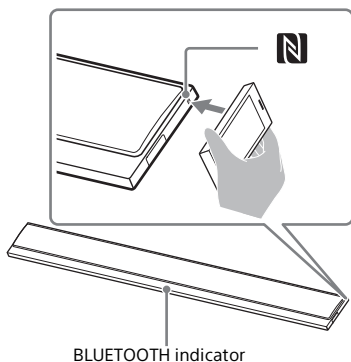

3 Make sure that the BLUETOOTH indicator lights in blue.

A connection between the system and mobile device has been established.

4 Start audio playback with the music app on the connected mobile device.

Sound is output from the system.

5 Adjust the volume.

- Adjust the volume by pressing \triangleleft +/- on the remote control.
- Adjust the subwoofer volume by pressing SW \triangleleft +/- on the remote control (page 27).
- You can play or pause the content by using the playback operation buttons on the remote control.

To stop playback by One-touch function

Touch the N mark on the unit with the mobile device again.

Notes

- Depending on your device, you may need to perform the following items on your mobile device in advance.
 - Turn on the NFC function.
 - Download the “NFC Easy Connect” application from Google Play™ and start the application. (The application may not be available in some countries/regions.) For details, refer to the operating instructions of your device.
- This feature does not work with BLUETOOTH-compatible headphones or speakers. To listen to sound using a BLUETOOTH-compatible headphones or speakers, see “Listening to Sound of the Connected TV or Device from Headphones or Speakers” (page 32).
- [Bluetooth Mode] is changed to [Receiver] automatically when making BLUETOOTH connection with the One-touch function. Even if the One-touch function is canceled, the [Bluetooth Mode] setting remains as [Receiver]. For details about [Bluetooth Mode], see [Bluetooth Settings] (page 50).

Listening to Sound of the Connected TV or Device from Headphones or Speakers

You can listen to sound of the connected TV or device from BLUETOOTH-compatible headphones or speakers by connecting it with the BLUETOOTH function.

Listening to Sound by Pairing with Headphones or Speakers

- 1 Press HOME.**
The home menu appears on the TV screen.
- 2 Select  [Setup] from the home menu.**
The setup display appears on the TV screen.
- 3 Select [Bluetooth Settings] - [Bluetooth Mode] - [Transmitter].**
The system enters BLUETOOTH transmission mode.
- 4 Set the BLUETOOTH-compatible headphones or speaker to the pairing mode.**
Refer to the operating instructions of the headphones or speaker for pairing method.
- 5 Select the name of the headphones or speaker from the [Device List] in [Bluetooth Settings].**
When the BLUETOOTH connection is established, [Bluetooth device is connected.] appears. (The

connected device name also appears.)

If you cannot find name of your headphones or speaker in [Device List], select [Scan].

- 6 Return to the home menu and select the desired input.**

The image of the selected input appears on the TV screen, "BT TX" appears in the front panel display, then the sound is output from the headphones or speaker.

No sound is output from the system.

For selecting input, see "Using the Home Menu" (page 12).

- 7 Adjust the volume.**

Adjust the volume level of the headphones or speaker first. When connected with headphones or speakers, the volume level of the headphones or speaker can be controlled with VOL +/- on the unit and \triangle +/- on the remote control.

To cancel pairing

Cancel pairing of the headphones or speaker in step 4.

To remove a registered device from the device list

- Follow steps 1 to 5 of "Listening to Sound by Pairing with Headphones or Speakers."
- Select the name of the headphones or speaker, and then press OPTIONS.
- Select [Remove].
- Follow the on-screen instructions to delete the desired headphones or speaker from the device list.

Listening to Sound with Paired Headphones or Speakers

1 Press HOME.

The home menu appears on the TV screen.

2 Select the desired input.

For selecting input, see "Using the Home Menu" (page 12).

3 Set the BLUETOOTH function of the headphones or speaker to on.

4 Press RX/TX on the remote control.

[Bluetooth Mode] is set to [Transmitter] and "BT TX" appears in the front panel display.

The system automatically reconnects to the headphones or speaker it was most recently connected to, then the sound is output from the headphones or speaker.

No sound is output from the system.

5 Adjust the volume.

Adjust the volume level of the headphones or speaker. You can also adjust volume level of the headphones or speaker with \triangle +/- on the remote control.

To disconnect the headphones or speaker

Perform any of the following items.

- Disable the BLUETOOTH function on the headphones or speaker.
- Press RX/TX.
- Turn off the system, or the headphones or speaker.
- Select the device name of the connected headphones or speaker from [Setup] - [Bluetooth Settings] - [Device List].

About the Connection of the Headphones or Speaker

- You may not be able to adjust the volume level depending on the BLUETOOTH-compatible headphones or speaker.
- [Screen mirroring], [Bluetooth Audio], and Home Theatre Control function are disabled when [Bluetooth Mode] is set to [Transmitter].
- When input of [Bluetooth Audio] or [Screen mirroring] is selected, you cannot set [Bluetooth Mode] to [Transmitter]. You cannot switch it with RX/TX on the remote control neither.
- You can register up to 9 BLUETOOTH devices. If a 10th BLUETOOTH device is registered, the least recently connected BLUETOOTH device will be replaced by the new one.
- The system can display up to 15 detected BLUETOOTH device in the [Device List].
- You cannot change the sound effect or settings in the options menu while transmitting sound to the BLUETOOTH-compatible headphones or speaker.
- Some content may not be output due to content protection.
- Playback of audio/music on the BLUETOOTH device is delayed compared to that on the unit due to the characteristics of BLUETOOTH wireless technology.
- You can enable or disable the reception of AAC or LDAC audio from the BLUETOOTH device (page 51).

Enjoying with the Network Function

Listening to Music on your PC via a Home Network

You can play music files stored on your PC via your home network. Music files can be played by operating on the on-screen display (OSD) of the system or dedicated app SongPal on a mobile device such as a smartphone or tablet.

Preparing the Home Network



- 1 Connect the system to a network.**
See "Connecting to a Wired Network" (page 18) and "Connecting to a Wireless Network" (page 20).
- 2 Connect the PC to a network.**
For details, refer to the operating instructions of the PC.
- 3 Set the PC.**
To use the PC on your home network, you need to set the PC as the server. For details, refer to the operating instructions of the PC.

Tip

See  [Setup] - [Network Settings] - [Network Connection Status] when checking the network connection status.

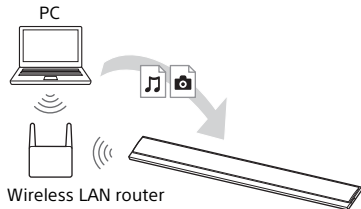
Listening to Music on a PC



- 1 Press HOME.**
The home menu appears on the TV screen.
- 2 Select [Home Network] from the home menu.**
The device name on your home network appears on the TV screen.
- 3 Select the desired device - [Music] - folder on which songs are stored - song.**
The selected song is played and sound is output from the system.
- 4 Adjust the volume.**
 - Adjust the volume by pressing  +/- on the remote control.
 - Adjust the subwoofer volume by pressing SW  +/- on the remote control (page 27).

Tips

- You can view photos stored on the PC by selecting [Photo] in step 3.
- You can perform various operations from the options menu (page 56).

Listening to Music on a PC by Using SongPal

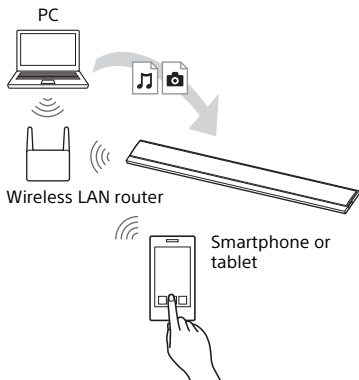

You can play music files stored on the PC by operating the dedicated app SongPal that is downloaded to a mobile device such as a smartphone or tablet. For details of SongPal, see “What You can Do with SongPal” (page 36) or the following URL.
<http://info.songpal.sony.net/help/>

Listening to Music on Music Services

You can listen to music services offered on the Internet with this system. To use this function, the system must be connected to the Internet.

- 1 Press HOME.**
The home menu appears on the TV screen.
- 2 Select [Music Services] from the home menu.**
The music services list appears on the TV screen.
- 3 Select the desired music service.**
The guide for enjoying the music service appears on the TV screen. Follow the guide to enjoy the music services.

Tip

You can update the service provider list by pressing **OPTIONS** and selecting [Update Services] in step 2.

Listening to Music on the Mobile Device with SongPal

What You can Do with SongPal

SongPal is an application for controlling compatible Sony audio devices using your smartphone/iPhone. Search for SongPal at Google Play™ or the App Store and download it onto your smartphone/iPhone.

For details about SongPal, refer to the following URL.
<http://info.songpal.sony.net/help/>

Downloading SongPal on to your smartphone/iPhone provides the following.

Sound settings of the system

You can easily customize your sound, or use the [ClearAudio+] setting recommended by Sony.

Music service

You can configure the initial settings to use music services*.

* Depending on the country and region, music services and their period of availability may differ.

An update of the device may be required. When using Google Cast™ on music service, see "Using Google Cast" (page 37).

Enjoying music on your home network

You can play music stored in your PC or home network server over your network.

Enjoying music on the USB device

You can play music on a device connected to the  (USB) port on the unit.

Note

What you can control with SongPal varies depending on the connected device. The specification and design of the application may change without notice.

Using SongPal

- 1 **Download the free SongPal app to the mobile device.**
- 2 **Connect the system and mobile device with the BLUETOOTH function (page 29) or network function (page 18).**
- 3 **Start SongPal.**
- 4 **Operate by following the SongPal screen.**

Notes

- Before using SongPal, be sure to set the [Bluetooth Mode] to [Receiver] (page 50).
- Use SongPal of the latest version.

Tips

- You can connect the system and mobile device with the NFC function (page 30).
- When connecting with the network function, connect the mobile device to the same network as that of the system.

Using Google Cast

Google Cast allows you to select music content from the Google Cast-enabled app and play back on the unit.

Google Cast requires the initial setup using SongPal.

- 1 **Download the free SongPal app to the mobile device.**
- 2 **Connect the device by Wi-Fi to the same network as that of the system (page 20).**
- 3 **Start SongPal, select the system, and tap [Settings] - [Google Cast] - [Learn how to Cast].**
- 4 **Check the operation and Google Cast-enabled apps, and download the app.**
- 5 **Start the Google Cast-enabled app, tap the cast button, and select the system.**



- 6 **Select and play music on the Google Cast-enabled app.**
The music is played on the system.

Note

You cannot use Google Cast while "google cast updating" is shown on the front panel display of the unit. Wait until the update is complete, and then try again.

Listening to Music by Connecting the SongPal Link-Compatible Device

Listening to the Same Music in Different Rooms (Wireless Multi Room)

You can listen to your music stored in your PCs or smartphones and furthermore, music from network services, in different rooms with ultimate sound quality.

You can operate with the SongPal app that is installed on a smartphone/iPhone. To use multiple SongPal-compatible devices, connect them to the same wireless LAN.

To perform setting on SongPal

Perform the setting by following the help on SongPal.

Tip

For details about SongPal, see "What You can Do with SongPal" (page 36).

Wireless Multi-room



Displaying the Screen of the Mobile Device on a TV (MIRRORING)

[Screen mirroring] is a function to display the screen of a mobile device on the TV by Miracast technology.

The system can be connected directly with a Screen mirroring-compatible device (e.g. smartphone, tablet). You can enjoy using the display screen of the device on your large TV screen. No wireless router (or access point) is required to use this feature.

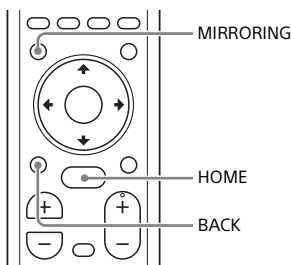

- 1 Press **MIRRORING**.
- 2 Follow the on-screen instructions on the TV screen.

Activate the Screen mirroring function from your mobile device. The screen of the mobile device appears on the TV screen.

Tips

- You can select [Screen mirroring] from the home menu in step 1.
- You can improve the playback stability by setting [Screen mirroring RF Setting] (page 54).

Notes

- When using Screen mirroring, the quality of picture and sound may sometimes be deteriorated due to interference from other networks.
- Depending on the usage environment, the quality of the picture and sound may be deteriorated.
- Some network functions may not be available during Screen mirroring.
- Make sure that your device is compatible with Miracast. Connectivity with all Miracast compatible devices is not guaranteed.

Canceling Screen Mirroring

Press **HOME** or **BACK**.

Using the Various Functions/ Settings

Performing the Wireless Connection of the Subwoofer (LINK)

Perform the wireless connection of the subwoofer again for a better connection.

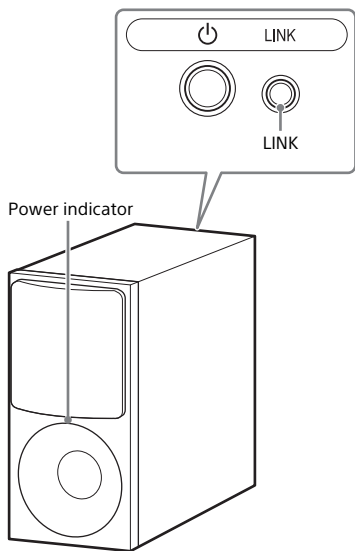

1 Press HOME.

The home menu appears on the TV screen.

2 Select [Setup] from the home menu.

The setup display appears on the TV screen.

3 Select [System Settings] - [Wireless Subwoofer Connection] - [Link].

The [Link] screen appears on the TV screen.

4 Press LINK on the rear of the subwoofer.

The power indicator of the subwoofer flashes in green. Proceed to the next step within 1 minute.

5 Select [Start].

The link setting starts. To return to the previous display, select [Cancel].

6 Complete the link setting by following the on-screen message.

The power indicator of the subwoofer lights in green.

Notes

- If the message [Cannot set Link.] appears, follow the on-screen instructions.
- When [Bluetooth Mode] is set to [Transmitter] and the BLUETOOTH device is connected to the system, the wireless subwoofer connection cannot be established.

Playing Compressed Audio Files with Natural Sound Quality

This function enhances the sound quality of compressed audio files by restoring high-range sound removed by the compression process. You can enjoy listening to sound close to its original, natural and spatial sound.

This function is only available when [Music] is selected as the sound field (page 25).

- 1 Press HOME.**
The home menu appears on the TV screen.
- 2 Select  [Setup] from the home menu.**
The setup display appears on the TV screen.
- 3 Select [Audio Settings] - [DSEE].**
- 4 Select [On].**

Notes

- This function is compatible with 2-channel digital input signals of 44.1 kHz or 48 kHz sampling frequency.
- The sampling frequency/bit depth after upscaling is up to 96 kHz/24 bit.
- This function is not compatible with DSD signals.
- This function does not work when [Analog] is selected.

Enjoying Multiplex Broadcast Sound (AUDIO)

You can enjoy multiplex broadcast sound when the system receives a Dolby Digital multiplex broadcast signal.

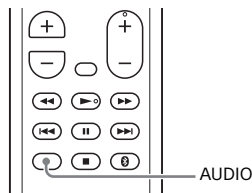

- 1 Press AUDIO.**
The audio signal appears in the front panel display.
- 2 Press the button repeatedly to select the desired audio signal.**

Audio signal	Explanation
"MAIN"	Sound of the main language will be output.
"SUB"	Sound of the sub language will be output.
"MN/SB"	Mixed sound of both the main and sub languages will be output.

Notes

- To receive a Dolby Digital signal, you need to connect a TV or other devices to the TV IN (OPTICAL) jack with the optical digital cable (supplied).
- If your TV's HDMI IN jack is compatible with the Audio Return Channel function (page 45), you can receive a Dolby Digital signal via HDMI cable.

Deactivating Buttons on the Unit

You can deactivate buttons on the unit for preventing misoperation, such as child mischief (Child lock function).

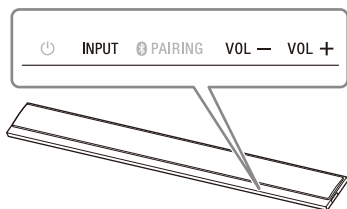

Press **VOL -**, **VOL +**, and **VOL -** in order while pressing and holding **INPUT** on the unit.

“LOCK” appears in the front panel display, and buttons on the unit do not work.

You can only operate the unit by using the remote control.

Canceling the Child Lock Function

Press **VOL -**, **VOL +**, and **VOL -** in order while pressing and holding **INPUT** on the unit.

“UNLCK” appears in the front panel display, and the child lock function is canceled.

Note

⏻ (power) is not locked with the child lock function.

Changing the Brightness of the Front Panel Display and BLUETOOTH Indicator (DIMMER)

You can change the brightness of the front panel display and BLUETOOTH indicator.

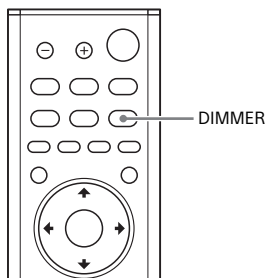

1 Press DIMMER.

The display mode appears in the front panel display.

2 Press the button repeatedly to select the desired display mode.

Mode	Explanation
“BRIGHT”	The front panel display and BLUETOOTH indicator light brightly.
“DARK”	The front panel display and BLUETOOTH indicator light darkly.
“OFF”	The front panel display is turned off.

Note

The front panel display is turned off when "OFF" is selected. It turns on automatically when you press any button, then turns off again if you do not operate the system for about 10 seconds. However, in some cases, the front panel display may not turn off. In this case, the brightness of the front panel display is same as "DARK."

Saving Power in Standby Mode

Check that you have made the following settings:

- [Bluetooth Standby] is set to [Off] (page 51).
- [Standby Through] is set to [Off] (page 52).
- [Quick Start/Network Standby] is set to [Off] (page 53).
- [Remote Start] is set to [Off] (page 54).

Using the Control for HDMI Function

Connecting a device such as a TV or Blu-ray Disc recorder compatible with the Control for HDMI function* by HDMI cable enables you to easily operate the device by a TV remote control. The following functions can be used with the Control for HDMI function.

- System Power Off function
- System Audio Control function
- Audio Return Channel
- One-Touch Play function
- Remote Easy Control
- HDMI Standby Through power saving setting

Note

These functions may work with devices other than those manufactured by Sony, but operation is not guaranteed.

* Control for HDMI is a standard used by CEC (Consumer Electronics Control) for allowing HDMI (High-Definition Multimedia Interface) devices to control each other.

Preparing to Use the Control for HDMI Function

Turn [System Settings] - [HDMI Settings] - [Control for HDMI] on the system to [On] (page 52). The default setting is [On].

Enable the Control for HDMI function settings for the TV and other device connected to the system.

Tip

If you enable the Control for HDMI ("BRAVIA" sync) function when using a TV manufactured by Sony, the Control for HDMI function of the system is also enabled automatically. When settings are

completed, "DONE" appears in the front panel display.

System Power Off Function

When you turn off the TV, the system and the connected device will turn off automatically.

Set [System Settings] - [HDMI Settings] - [Standby Linked to TV] on the system to [On] or [Auto] (page 52). The default setting is [Auto].

Note

The connected device may not turn off depending on the status of the device.

System Audio Control Function

If you turn on the system while you are watching the TV, the TV sound will be output from the speakers of the system. The volume of the system can be adjusted using the TV's remote control. If the TV sound was output from the speakers of the system the previous time you watched the TV, the system will be turned on automatically when you turn on the TV again. Operations can also be made by the TV's menu. For details, refer to the operating instructions of your TV.

Notes

- Sound is only output from the TV if other than [TV], [HDMI1], [HDMI2] or [HDMI3] input is selected when using the Twin Picture function on the TV. When you disable the Twin Picture function, the sound is output from the system.
- The number for the system's volume level is displayed on the TV screen depending on the TV. The volume number displayed on the TV may differ from the number on the front panel display of the system.

- Depending on the settings of the TV, the System Audio Control function may not be available. For details, refer to the operating instructions of your TV.

Audio Return Channel

If the system is connected to a TV's HDMI IN jack compatible with Audio Return Channel, you can listen to TV sound from the speakers of the system without connecting an optical digital cable.

On the system, turn [System Settings] - [HDMI Settings] - [Audio Return Channel] to [Auto] (page 52). The default setting is [Auto].

Note

If the TV is not compatible with Audio Return Channel, the optical digital cable (supplied) needs to be connected (refer to the supplied Startup Guide).

One-Touch Play Function

When you play content on a device (Blu-ray Disc recorder, "PlayStation®4," etc.) connected to the system, the system and TV are turned on automatically, the input of the system is switched to the input for the device played, and sound is output from the speakers of the system.

Notes

- If [System Settings] - [HDMI Settings] - [Standby Through] on the system is set to [On] or [Auto] and the TV sound was output from the speakers of the TV the previous time you watched the TV, the system does not turn on and the sound and picture are output from the TV even if device content is played (page 52).
- Depending on the TV, the beginning part of content being played may not play correctly.

Remote Easy Control

You can operate the system by selecting the system from the TV's Sync Menu. This function can be used if the TV supports the Sync Menu. For details, refer to the operating instructions of your TV.

Notes

- In the TV's link menu, the system is recognized by the TV as "Player."
- Some operations may not be available with some TVs.

HDMI Standby Through Power Saving Setting

HDMI Standby Through power saving setting (page 52) is a function that allows you to enjoy the sound and picture of a connected device without turning on the system.

Set [System Settings] - [HDMI Settings] - [Standby Through] to [Auto] (page 52). The default setting is [Auto].

Note

If the picture of a device connected to the system is not displayed on the TV, set [Standby Through] to [On]. If you connect a TV other than those manufactured by Sony, we recommend you to select this setting.

Using the “BRAVIA” Sync Function

In addition to the Control for HDMI function, you can also use the following functions on devices compatible with the “BRAVIA” sync function.

- Scene Select function
- Home Theatre Control
- Echo Canceling function
- Language Follow

Note

These functions are proprietary functions of Sony. This function cannot operate with products other than those manufactured by Sony.

Scene Select Function

The sound field of the system is automatically switched according to the TV’s Scene Select function settings. For details, refer to the operating instructions of your TV.

Set the sound field to [ClearAudio+] (page 25).

Home Theatre Control Function

When using a TV compatible with the Home Theatre Control function, setting the system, setting the sound field settings, input switching, etc. can be done without switching the TV input. This function can be used when the TV is connected to the Internet. For details, refer to the operating instructions of your TV.

Echo Canceling Function

Echo is reduced when you use Social Viewing function such as Skype while watching TV programs. This function can be used if the TV supports Social Viewing function. For details, refer to the operating instructions of your TV.

Notes

- If the input of the system is [HDMI1], [HDMI2] or [HDMI3] when using the Social Viewing function, the input is automatically changed to [TV]. Sound of the Social Viewing and TV program is output from the speakers of the system.
- Sound is only output from the speaker of the TV if the input of the system is other than [TV], [HDMI1], [HDMI2] or [HDMI3] when using the Social Viewing function.
- This function cannot be used when sound is output from the TV.

Language Follow

When you change the language for the on-screen display of the TV, the system’s on-screen display language is also changed.

Notes on HDMI connections









- Use an HDMI cable (High Speed HDMI Cable with Ethernet or Premium High Speed HDMI Cable with Ethernet). If you use a standard HDMI cable, 1080p, 3D, and 4K content may not be displayed properly.
- Use an HDMI-authorized cable.
- Use a Sony High Speed HDMI Cable with Ethernet with the Type Logo.
- We do not recommend using an HDMI-DVI conversion cable.
- Audio signals (sampling frequency, bit length, etc.) transmitted from an HDMI jack may be suppressed by the connected device.

- Sound may be interrupted when the sampling frequency or the number of channels of audio output signals from the playback device is switched.
- When [TV] input is selected, video signals via one of the HDMI IN 1/2/3 jacks selected last time are output from the HDMI OUT (ARC) jack.
- This system supports "TRILUMINOS," ITU-R BT.2020, HDR (High Dynamic Range), 3D, and 4K transmission.

Using the Setup Display

You can make various adjustments to items such as picture and sound. The default settings are underlined.

- 1 Press HOME.**
The home menu appears on the TV screen.
- 2 Select  [Setup] from the home menu.**
The setup display appears on the TV screen.
- 3 Select the setting item.**

Setting item	Explanation
 [Software Update]	Updates the software of the system. (page 49)
 [Screen Settings]	Makes the screen settings according to the type of TV. (page 49)
 [Audio Settings]	Makes the audio settings according to the type of connection jacks. (page 50)
 [Bluetooth Settings]	Makes detailed settings for the BLUETOOTH function. (page 50)
 [System Settings]	Makes the system-related settings. (page 52)
 [Network Settings]	Makes detailed settings for the Internet and home network. (page 54)
 [Input Skip Setting]	Sets the input skip setting for each input. (page 54)
 [Easy Setup]	Re-runs the Easy Setup to make the basic settings. (page 55)
 [Resetting]	Resets the system to the factory default settings. (page 55)

[Software Update]

By updating your software to the latest version, you can take advantage of the newest functions.

For information about update functions, visit the following website:
www.sony.eu/support

Notes

- An Internet environment is necessary to perform updates via Internet.
- During a software update, “UPDT” appears in the front panel display. After the update is complete, the system automatically reboots. While the updating operation is in progress, do not turn on or off the system or operate the system or TV. Wait for the software update to complete.
- Set [Auto Update] to [On] when you want to perform software updates automatically (page 53). Software update may be performed even if you select [Off] in [Auto Update] depending on the details of the updates.

[Update via Internet]

Updates the system’s software using the available network. Follow the instructions on the screen. Make sure network is connected to the Internet.

[Update via USB Memory]

Updates software using USB memory. Make sure that the software update folder is correctly named “UPDATE.”

[Screen Settings]

[TV Type]

[16:9]: Select this when connecting to a wide-screen TV or a TV with a wide-mode function.

[4:3]: Select this when connecting to a 4:3 screen TV without a wide-mode function.

[Output Video Resolution]

[Auto]: Outputs video signal according to the resolution of the TV or connected device.

[480i/576i]*, [480p/576p]*, [720p], [1080i], [1080p]: Outputs video signal according to the selected resolution setting.

- * If the color system of the playback content is NTSC, the video signals resolution can be converted to [480i] and [480p] only.

[24p Output]

[Network content 24p Output]

This function sets the signals output from the HDMI OUT (ARC) jack on the system when using the Screen mirroring function.

[Auto]: Outputs 24p video signals only when you connect a 1080/24p-compatible TV via an HDMI connection and the [Output Video Resolution] is set to [Auto] or [1080p].

[Off]: Select this when your TV is not compatible with 1080/24p video signals.

[4K Output]

[Auto1]: Outputs 2K video signals during Screen mirroring and 4K video signals during photo playback when connected to a 4K-compatible device manufactured by Sony.

[Auto2]: Outputs 4K video signals during 24p content playback with Screen mirroring or photo playback when you connect a 4K/24p-compatible device.

[Off]: Turns off the function.

Notes

- If your device manufactured by Sony is not detected when [Auto1] is selected, the setting will have the same effect as [Auto2] setting.
- [Network content 24p Output] in [24p Output] needs to be set appropriately for [Auto2].

[YCbCr/RGB (HDMI)]

[Auto]: Automatically detects the type of external device, and then switches to the matching color setting.

[YCbCr (4:2:2)]: Outputs YCbCr 4:2:2 video signals.

[YCbCr (4:4:4)]: Outputs YCbCr 4:4:4 video signals.

[RGB]: Select this when connecting to a device with an HDCP compliant DVI jack.

[Video Direct]

You can disable the On-Screen Display (OSD) of the system when [HDMI1], [HDMI2] or [HDMI3] input is selected. This function is useful when playing a game, you can fully enjoy the game's screen.

[On]: Disables the OSD. Information will not display on the TV screen and the OPTIONS and DISPLAY buttons will not work.

[Off]: Displays information on the TV screen only when you change the settings, such as when selecting the sound field.

[SBM] (Super Bit Mapping)

[On]: Smooths the gradation of video signals output from the HDMI OUT (ARC) jack.

[Off]: Select this if video signals are distorted or color is unnatural.

[Audio Settings]

[DSEE]

This function is only available when [Music] is selected as the sound field.

[On]: Enhances sound quality by restoring high-range sound (page 41).

[Off]: Off

[Audio DRC]

You can compress the dynamic range of the sound track.

[Auto]: Automatically compresses sound encoded in Dolby TrueHD.

[On]: The system reproduces the sound track with the kind of dynamic range that the recording engineer intended.

[Off]: No compression of dynamic range.

[Attenuation settings - Analog]

Distortion may occur when you listen to a device connected to the ANALOG IN jacks. You can prevent distortion by attenuating the input level on the system.

[On]: Attenuates the input level. The output level will decrease at this setting.

[Off]: Normal input level.

[Audio Output]

You can select the output method used for audio signal output.

[Speaker]: Outputs multi-channel sound from the system's speakers only.

[Speaker + HDMI]: Outputs multi-channel sound from the system's speakers and 2-channel linear PCM signals from the HDMI OUT (ARC) jack.

[HDMI]: Outputs sound from the HDMI OUT (ARC) jack only. Sound format depends on the connected device.

Notes

- When [Control for HDMI] is set to [On] (page 52), [Audio Output] is set to [Speaker + HDMI] automatically and this setting cannot be changed.
- Audio signals are not output from the HDMI OUT (ARC) jack when [Audio Output] is set to [Speaker + HDMI] and [HDMI1 Audio Input Mode] (page 52) is set to [TV]. (Europe models only)

[Bluetooth Settings]

[Bluetooth Mode]

You can enjoy content from a BLUETOOTH device by using this system or listen to sound from this system by

using BLUETOOTH-compatible headphones or speaker.

[Receiver]: This system is in receiver mode, which enables it to receive and output audio from the BLUETOOTH device.

[Transmitter]: This system is in transmitter mode, which enables it to send audio to the BLUETOOTH-compatible headphones or speaker. If you switch the input of the system, "BT TX" appears on the front panel display.

[Off]: The BLUETOOTH function is turned off and you cannot select the [Bluetooth Audio] input.

Note

You can connect to a BLUETOOTH device by using the One-touch function even if you have set [Bluetooth Mode] to [Off].

[Device List]

Displays a list of paired and detected BLUETOOTH devices (SNK device) when [Bluetooth Mode] is set to [Transmitter].

[Bluetooth Standby]

You can set the [Bluetooth Standby] so that the system can be turned on by a BLUETOOTH device even when the system is in standby mode. This function is only available when you set [Bluetooth Mode] to [Receiver] or [Transmitter].

[On]: The system turns on automatically when you request a BLUETOOTH connection from a paired BLUETOOTH device.

[Off]: Off

[Bluetooth Codec - AAC]

This function is only available when you set [Bluetooth Mode] to [Receiver] or [Transmitter].

[On]: Enable AAC codec.

[Off]: Disable AAC codec.

Notes

- You can enjoy high-quality sound if AAC is enabled and your device supports AAC.
- When connecting BLUETOOTH-compatible headphones or speakers, this setting cannot be changed.

[Bluetooth Codec - LDAC]

This function is only available when you set [Bluetooth Mode] to [Receiver] or [Transmitter].

[On]: Enable LDAC codec.

[Off]: Disable LDAC codec.

Notes

- You can enjoy more high-quality sound if LDAC is enabled and your device supports LDAC.
- When connecting BLUETOOTH-compatible headphones or speakers, this setting cannot be changed.

[Wireless Playback Quality]

You can set the transmission data rate of LDAC playback. This function is only available when you set [Bluetooth Mode] to [Transmitter] and [Bluetooth Codec - LDAC] to [On].

[Auto]: The data transfer rate is automatically changed depending on the environment. If audio playback is unstable in this mode, use the other three modes.

[Sound Quality]: The highest bit rate is used. Sound is sent in a higher quality; however, audio playback sometimes may become unstable when the link quality is not good enough.

[Standard]: The middle bit rate is used. It balances both sound quality and playback stability.

[Connection]: Stability is prioritized. Sound quality may be reasonable and connection status will most likely be stable. If the connection is unstable, this setting is recommended.

[System Settings]

[OSD Language]

You can select the language you want for the system on-screen display.

[Wireless Subwoofer Connection]

You can perform wireless connection of the subwoofer again. For details, see "Performing the Wireless Connection of the Subwoofer (LINK)" (page 40).

[HDMI Settings]

- [Control for HDMI] (page 44)
[On]: The Control for HDMI function is enabled. Devices connected with an HDMI cable can control each other.
[Off]: Off
- [Standby Linked to TV] (page 44)
This function is available when you set [Control for HDMI] to [On].
[Auto]: If the input of the system is [TV], [HDMI1], [HDMI2], [HDMI3], or [Screen mirroring], the system turns off automatically when you turn off the TV.
[On]: The system turns off automatically when you turn off the TV regardless of the input.
[Off]: The system does not turn off when you turn off the TV.
- [Audio Return Channel] (page 45)
Set this function when the system is connected to a TV's HDMI IN jack that is compatible with Audio Return Channel. The function is available when you set [Control for HDMI] to [On].
[Auto]: You can listen to TV sound from the speakers of the system.
[Off]: Use this setting when an optical digital cable is connected.
- [Standby Through] (page 45)
This function is available when you set [Control for HDMI] to [On].
[Auto]: Signals are output from the system's HDMI OUT (ARC) jack when the TV is turned on while the system is not turned on. The system standby power consumption can be reduced more than when set to [On].
[On]: Signals are always output from the system's HDMI OUT (ARC) jack when the system is not turned on. If you connect a TV other than those manufactured by Sony, we recommend that you select this setting.
[Off]: Signals are not output from the system's HDMI OUT (ARC) jack when the system is not turned on. Turn on the system to enjoy on the TV content of a device connected to the system. The system standby power consumption can be reduced more than when set to [On].
- [HDMI1 Audio Input Mode] (Europe models only)
You can select the audio input of the device that is connected to the HDMI IN 1 jack.
[HDMI1]: The sound of the device that is connected to the HDMI IN 1 jack is input from the HDMI IN 1 jack.
[TV]: The sound of the device that is connected to the HDMI IN 1 jack is input from the TV IN (OPTICAL) jack.
- [HDMI Signal Format]
When you display High-Quality 4K format* with the HDMI input, perform this setting.
[Standard format]: Standard format for normal use.

[Enhanced format]: High-Quality HDMI format. Set only when using capable devices.

Notes

- Select [Enhanced format] only when the connected device and TV support High-Quality 4K* format.
- Depending on the TV, the TV setting may be required. Refer to the operating instructions of the TV.
- The picture may not be displayed properly if this setting is changed. In this case, change this setting to [Standard format].
- When watching 4K picture with High-Quality*, use a Premium High Speed HDMI cable that supports speeds of 4K 60p 18Gbps.
 - * 4K 60p 4:4:4, 4:2:2, 4K 60p 4:2:0 10 bit, etc. For details, see "Supported Input Video Formats" (page 69).

[Quick Start/Network Standby]

[On]: Shortens the startup time from standby mode. You can operate the system quickly after turning it on.

[Off]: Off

[Auto Standby]

[On]: Turns on the [Auto Standby] function. When you do not operate the system for about 20 minutes, the system enters standby mode automatically.

[Off]: Off

[Auto Display]

[On]: Automatically displays information on the TV screen when changing the audio signals, picture mode, etc.

[Off]: Displays information only when you press DISPLAY.

[Software Update Notification]

[On]: Sets the system to inform you of latest software version information (page 49).

[Off]: Off

[Auto Update Settings]

[Auto Update]

[On]: Software update is automatically executed between 2 a.m. and 5 a.m. local time in the selected [Time Zone] while this system is not in use. If you select [Off] in [Quick Start/Network Standby], software update is performed after you turn off the system.

[Off]: Off

[Time Zone]

Select your country/region.

Notes

- Software update may be performed even if you select [Off] in [Auto Update] depending on the details of the updates.
- Software update is performed automatically within 11 days of a new software release.

[Device Name]

You can change the name of this system according to your preference so that it is more recognizable when using the [Bluetooth Audio] or [Screen mirroring] function. The name is also used with other networks, such as the home network. Follow on-screen instructions and use the software keyboard to enter the name.

[System Information]

You can display the system's software version information and the MAC address.

[Software License Information]

You can display the Software License Information.

[Network Settings]

[Internet Settings]

Connect the system to the network beforehand.

[Wired Setup]: Select this when you connect to a broadband router using a LAN cable.

[Wireless Setup]: Select this when you use the built-in Wi-Fi function of the system to connect to a wireless network.

Tip

For further details, visit the following website and check the FAQ: www.sony.eu/support

[Network Connection Status]

Displays the current network connection status.

[Network Connection Diagnostics]

You can run the network diagnostic to check if the network connection has been made properly.

[Screen mirroring RF Setting]

If you use multiple wireless systems, such as a wireless LAN, the wireless signals may be unstable. In this case, playback stability may be improved by setting the priority radio frequency channel for Screen mirroring.

[Auto]: Normally select this. The system automatically selects the best channel for Screen mirroring.

[CH 1]/[CH 6]/[CH 11]: The selected channel is prioritized for Screen mirroring connection.

[Connection Server Settings]

Sets whether or not to display the connected home network server.

[Auto Home Network Access Permission]

[On]: Allows automatic access from a newly detected home network controller.

[Off]: Off

[Home Network Access Control]

Displays a list of home network controller-compatible products and sets whether or not to accept commands from the controllers in the list.

[External Control]

[On]: Allows the home automation controller to operate this system.

[Off]: Off

[Remote Start]

[On]: Allows you to turn on the system by a device linked via a network when the system is in standby mode.

[Off]: The system cannot be turned on by a device linked via a network.

[Input Skip Setting]

The skip setting is a convenient feature that allows you to skip unused inputs when selecting a function by pressing INPUT +/-.

[Do not skip]: The system does not skip the selected input.

[Skip]: The system skips the selected input.

Note

When you press INPUT +/- during the home menu is displayed, input icon appears dimmed if it has been set to [Skip].

Tip

You can perform [Input Skip Setting] from the options menu (page 56).



[Easy Setup]

Run [Easy Setup] to make the basic initial settings and the basic network settings for the system. Follow the on-screen instructions.



[Resetting]

[Reset to Factory Default Settings]

You can reset the system settings to the factory default by selecting the group of settings. All the settings within the group will be reset.

[Initialize Personal Information]

You can erase your personal information stored on the system.

Note

If you dispose, transfer or resell this system, please delete all Personal Information for security purposes. Please take appropriate measures such as logging out after using a network service.

Options Menu List

Various settings and playback operations are available by pressing **OPTIONS**. The available items differ depending on the situation.

Item	Explanation
[A/V SYNC]	Adjusts the time gap between picture and sound. Sound output can be delayed (page 27).
[Sound Field]	Changes the sound field setting (page 25).
[Night]	Selects the night mode (page 26).
[Voice]	Selects the voice mode (page 26).
[Input Skip Setting]	Skips unused inputs when selecting a function by pressing INPUT +/- (page 54).
[Input Label]	Changes the input name of [HDMI1], [HDMI2], or [HDMI3] that is displayed on the home menu (page 22).
[Repeat Setting]	Sets repeat playback.
[Play/Stop]	Starts or stops playback.
[Play from start]	Plays the item from the beginning.
[Shuffle Setting]	Sets shuffle playback.
[Add Slideshow BGM]	Registers music files on the USB memory as slideshow background music (BGM).
[Slideshow]	Starts a slideshow.
[Slideshow Speed]	Changes the slideshow speed.
[Slideshow Effect]	Sets the effect when playing a slideshow.
[Slideshow BGM]	<ul style="list-style-type: none">• [Off]: Turns off the function.• [My Music from USB]: Sets the music files registered in [Add Slideshow BGM].
[Change Display]	Switches between [Grid View] and [List View].
[Rotate Left]	Rotates the photo counterclockwise by 90 degrees.
[Rotate Right]	Rotates the photo clockwise by 90 degrees.
[View Image]	Displays the selected picture.

Troubleshooting

If you experience any of the following difficulties while using the system, use this troubleshooting guide to help remedy the problem before requesting repairs. Should any problem persist, consult your nearest Sony dealer. Be sure to bring both your unit and subwoofer, even if it seems as though only one has a problem, when you request to repair.

Power

The system does not power up.

- Check that the AC power cord (mains lead) is connected securely.
- Disconnect the AC power cord (mains lead) from the wall outlet (mains), and then reconnect after several minutes.

The system does not turn on even when the TV is turned on.

- Set [System Settings] - [HDMI Settings] - [Control for HDMI] to [On] (page 52). The TV must support the Control for HDMI function (page 44). For details, refer to the operating instructions of your TV.
- Check the speaker settings of the TV. The system power syncs with the speaker settings of the TV. For details, refer to the operating instructions of your TV.
- If the sound was output from the speakers of the TV the previous time, the system does not turn on even when the TV is turned on.

The system turns off when the TV is turned off.

- Check the setting of [System Settings] - [HDMI Settings] - [Standby Linked to TV] (page 52). When [Standby Linked to TV] is set to [On], the system turns off automatically when you turn off the TV regardless of the input.

The system does not turn off even when the TV is turned off.

- Check the setting of [System Settings] - [HDMI Settings] - [Standby Linked to TV] (page 52). To turn the system off automatically regardless of the input when you turn off the TV, set [Standby Linked to TV] to [On]. The TV must support the Control for HDMI function (page 44). For details, refer to the operating instructions of your TV.

Picture

There is no picture or the picture is not output correctly.

- Select the appropriate input (page 12).
- While pressing and holding INPUT, press VOL +, VOL -, VOL + on the unit in order to set the video output resolution setting to the lowest level.
- When there is no picture from the connected device or the picture from the connected device is not output correctly, set [System Settings] - [HDMI Settings] - [HDMI Signal Format] to [Standard format] (page 52).

There is no picture when you make an HDMI cable connection.

- If you connect a device supporting HDCP 2.2 be sure to connect the device to the HDMI IN jack and the TV to the HDMI OUT jack of the system.
- The system is connected to an input device that is not HDCP (High-

bandwidth Digital Content Protection) compliant. In this case, check the specifications of the connected device.

- Disconnect the HDMI cable, then connect it again. Make sure that the cable is firmly inserted.

3D content from the HDMI IN 1/2/3 jack do not appear on the TV screen.

- Depending on the TV or video device, 3D content may not appear. Check the supported HDMI video format (page 69).

4K content from the HDMI IN 1/2/3 jack do not appear on the TV screen.

- Depending on the TV or the video device, 4K content may not appear. Check the video capability and settings of your TV and video device.
- Use an HDMI cable (High Speed HDMI Cable with Ethernet or Premium High Speed HDMI Cable with Ethernet).

An image is not displayed on the entire TV screen.

- Check the setting of [TV Type] in [Screen Settings] (page 49).
- The aspect ratio on the media is fixed.

Images from the HDMI jack is distorted.

- Video from the device connected to the HDMI jack may be distorted. If this happens, set [Video Direct] to [On] (page 50).

Picture and sound are not output from the TV when the system is not turned on.

- Set on the system [System Settings] - [HDMI Settings] - [Control for HDMI] to [On], and then set [Standby Through] to [Auto] or [On] (page 52).
- Turn on the system, and then switch the input to that for the device playing.
- If connected to devices other than those manufactured by Sony that

support the Control for HDMI function, set [System Settings] - [HDMI Settings] - [Standby Through] to [On] (page 52).

Sound

No TV sound is output from the system.

- Check the type and connection of the HDMI cable, optical digital cable, or analog audio cable that is connected to the system and the TV (refer to the supplied Startup Guide).
- When the system is connected with a TV compatible with Audio Return Channel, make sure the system is connected to an ARC-compatible HDMI input terminal of the TV (refer to the supplied Startup Guide). If sound is still not output or if sound is interrupted, connect the optical digital cable (supplied) and set on the system [System Settings] - [HDMI Settings] - [Audio Return Channel] to [Off] (page 52).
- If your TV is not compatible with Audio Return Channel, connect the optical digital cable (supplied) (refer to the supplied Startup Guide). If the TV is not compatible with Audio Return Channel, TV sound will not be output from the system even if the system is connected to the TV's HDMI IN jack.
- If sound is not output from the system even if the system and TV are connected by optical digital cable or if the TV does not have an optical digital sound output jack, connect an analog audio cable (not supplied) and set on the system [System Settings] - [HDMI Settings] - [Audio Return Channel] to [Off] (page 52).
- Switch input of the system to [TV] (page 12).
- Increase the volume on the system or cancel muting.

- If sound of a cable TV (CATV) box/ satellite tuner connected to the TV is not output, connect the device to a HDMI IN jack of the system and switch input of the system to the input for the connected device (HDMI IN 1/2/3) (refer to the supplied Startup Guide).
- Depending on the order in which you connect the TV and the system, the system may be muted and "MUTING" is displayed on the front panel display of the system. If this happens, turn on the TV first, then the system.
- Set the speakers setting of the TV (BRAVIA) to Audio System. Refer to the operating instructions of your TV regarding how to set the TV.

Picture and sound are not output from the TV when the system is not turned on.

- Set on the system [System Settings] - [HDMI Settings] - [Control for HDMI] to [On], and then set [Standby Through] to [Auto] or [On] (page 52).
- Turn on the system, and then switch the input to that for the device playing.
- If connected to devices other than those manufactured by Sony that support the Control for HDMI function, set [System Settings] - [HDMI Settings] - [Standby Through] to [On] (page 52).

The sound is output from both the system and the TV.

- Mute the sound of the system or the TV.

The TV sound from this system lags behind the image.

- Set [A/V SYNC] to 0 msec if it is set to the range between 25 msec and 300 msec (page 27).

No sound or only very low-level sound of the device connected to the system is heard.

- Press \triangleleft + on the remote control and check the volume level (page 10).
- Press \otimes or \triangleleft + on the remote control to cancel the muting function (page 10).
- Make sure the input source is selected correctly. You should try other input sources by pressing INPUT +/- on the remote control several times (page 12).
- Check that all the cables and cords of the system and the connected device are firmly inserted.
- When you play content compatible with copyright protection technology (HDCP), it may not be output from the system.
- Set [System Settings] - [HDMI Settings] - [HDMI Signal Format] to [Standard format] (page 52).

No sound or only very low-level sound is heard from the subwoofer.

- Press SW \triangleleft + on the remote control to increase the subwoofer volume (page 27).
- Make sure that the power indicator on the subwoofer is lit in green. If not, see "No sound is heard from the subwoofer." (page 62).
- The subwoofer is for reproducing bass sound. In the case of input sources that contain very little bass sound components (i.e., a TV broadcast), the sound from the subwoofer may be difficult to hear.

The surround effect cannot be obtained.

- Depending on the input signal and the sound field setting, surround sound processing may not work effectively. The surround effect may be subtle, depending on the program or disc.

- To play multi-channel audio, check the digital audio output setting on the device connected to the system. For details, refer to the operating instructions supplied with the connected device.

USB Device Connection

The USB device is not recognized.

- Try the following:
 - ① Turn the system off.
 - ② Remove and reconnect the USB device.
 - ③ Turn the system on.
- Make sure that the USB device is securely connected to the  (USB) port (page 23).
- Check to see if the USB device or a cable is damaged.
- Make sure that the USB device is on.
- If the USB device is connected via a USB hub, disconnect it and connect the USB device directly to the system.

Mobile Device Connection

BLUETOOTH connection cannot be completed.

- Make sure that the BLUETOOTH indicator of the unit is lit (page 30).
- Make sure the BLUETOOTH device to be connected with is turned on and the BLUETOOTH function is enabled.
- Bring this system and the BLUETOOTH device closer together.
- Pair this system and the BLUETOOTH device again. You may need to cancel the pairing with this system using your BLUETOOTH device first.
- Pairing information may be deleted. Perform pairing operation again (page 29).

Pairing cannot be achieved.

- Bring this system and the BLUETOOTH device closer together.

- Make sure this system is not receiving interference from a wireless LAN device, other 2.4 GHz wireless devices, or a microwave oven. If a device that generates electromagnetic radiation is nearby, move the device away from this system.

You cannot use the NFC function.

- The NFC function does not work with BLUETOOTH-compatible headphones or speaker. To listen to sound using a BLUETOOTH-compatible headphones or speaker, see "Listening to Sound of the Connected TV or Device from Headphones or Speakers" (page 32).

No sound is output from the connected BLUETOOTH device.

- Make sure that the BLUETOOTH indicator of the unit is lit (page 30).
- Bring this system and the BLUETOOTH device closer together.
- If a device that generates electromagnetic radiation, such as a wireless LAN device, other BLUETOOTH devices, or a microwave oven is nearby, move the device away from this system.
- Remove any obstacle between this system and the BLUETOOTH device or move this system away from the obstacle.
- Reposition the connected BLUETOOTH device.
- Switch the wireless LAN frequency of any nearby Wi-Fi router or PC to 5 GHz range.
- Increase the volume on the connected BLUETOOTH device.

Headphones or Speaker Connection

BLUETOOTH connection cannot be completed.

- Make sure that the BLUETOOTH indicator of the unit is lit (page 7).
- Make sure the BLUETOOTH device to be connected with is turned on and the BLUETOOTH function is enabled.
- Bring this system and the BLUETOOTH device closer together.
- Pair this system and the BLUETOOTH device again. You may need to cancel the pairing with this system using your BLUETOOTH device first.
- Pairing information may be deleted. Perform pairing operation again (page 29).

Pairing cannot be achieved.

- Bring this system and the BLUETOOTH device closer together.
- Make sure this system is not receiving interference from a wireless LAN device, other 2.4 GHz wireless devices, or a microwave oven. If a device that generates electromagnetic radiation is nearby, move the device away from this system.

You cannot use the NFC function.

- The NFC function does not work with BLUETOOTH-compatible headphones or speaker. To listen to sound using a BLUETOOTH-compatible headphones or speaker, see "Listening to Sound of the Connected TV or Device from Headphones or Speakers" (page 32).

No sound is output from the connected BLUETOOTH device.

- Make sure that the BLUETOOTH indicator of the unit is lit (page 30).
- Bring this system and the BLUETOOTH device closer together.

- If a device that generates electromagnetic radiation, such as a wireless LAN device, other BLUETOOTH devices, or a microwave oven is nearby, move the device away from this system.
- Remove any obstacle between this system and the BLUETOOTH device or move this system away from the obstacle.
- Reposition the connected BLUETOOTH device.
- Switch the wireless LAN frequency of any nearby Wi-Fi router or PC to 5 GHz range.
- Increase the volume on the connected BLUETOOTH device.
- Set [Wireless Playback Quality] to [Connection] (page 51).

Wired LAN Connection

The system cannot connect to the network.

- Check the network connection (page 18) and the network settings (page 54).

Wireless LAN Connection

You cannot connect your PC to the Internet after [Wi-Fi Protected Setup™ (WPS)] is performed.

- The wireless settings of the router may change automatically if you use the Wi-Fi Protected Setup function before adjusting the settings of the router. In this case, change the wireless settings of your PC accordingly.

The system cannot connect to the network or the network connection is unstable.

- Make sure the wireless LAN router is on.



- Check the network connection (page 20) and the network settings (page 54).
- Depending on the usage environment (including the wall material), radio wave reception conditions, or obstacles between the system and the wireless LAN router, the possible communication distance may be shortened. Move the system and the wireless LAN router closer to each other.
- Devices that use a 2.4 GHz frequency band, such as a microwave, BLUETOOTH, or digital cordless device, may interrupt communication. Move the unit away from such devices, or turn off such devices.
- The wireless LAN connection may be unstable depending on the usage environment, especially while using the BLUETOOTH function of the system. In this case, adjust the usage environment.

The wireless router you want is not shown in the wireless network list.

- Press BACK to return to the previous screen, and try [Wireless Setup] again (page 20). If the wireless router you want is still not detected, select [New connection registration] from the network list, then select [Manual registration] to input a network name (SSID) manually.

Subwoofer

No sound is heard from the subwoofer.

- If the power indicator on the subwoofer does not light, try the following.
 - Make sure the AC power cord (mains lead) of the subwoofer is connected properly.
 - Press  (power) of the subwoofer to turn on the power.
- If the power indicator on the subwoofer flashes slowly in green or lights in red, try the following.
 - Move the subwoofer to a location near the unit so that the power indicator on the subwoofer lights in green.
 - Follow the steps in “Performing the Wireless Connection of the Subwoofer (LINK)” (page 40).
- If the power indicator on the subwoofer flashes in red, press  (power) of the subwoofer to turn off the power and check whether the ventilation opening of the subwoofer is blocked or not.
- The subwoofer is designed for playback of bass sound. When the input source does not contain much bass sound, as is the case with most TV programs, the bass sound may not be audible.
- Press SW  + on the remote control to increase the volume of the subwoofer (page 27).
- Set the night mode to [Off]. For details, see “Enjoying Clear Sound with Low Volume at Midnight (NIGHT)” (page 26).

Sound skips or has noise.

- If there is a device nearby that generates electromagnetic waves, such as a wireless LAN or a microwave oven in use, locate the system apart from it.

- If there is an obstacle between the unit and the subwoofer, move or remove it.
- Locate the unit and the subwoofer as close as possible.
- Switch the wireless LAN frequency of any nearby Wi-Fi router or PC to 5 GHz range.
- Switch the network connection of the TV or Blu-ray Disc Player from wireless to wired.

Remote Control

The remote control of this system does not function.

- Point the remote control at the remote control sensor on the unit (page 7).
- Remove any obstacles in the path between the remote control and the system.
- Replace both batteries in the remote control with new ones, if they are weak.
- Make sure you are pressing the correct button on the remote control.

Others

The Control for HDMI function does not work properly.

- Check the connection with the system (refer to the supplied Startup Guide).
- Enable the Control for HDMI function on the TV. For details, refer to the operating instructions of your TV.
- Wait a while, and then try again. If you unplug the system, it will take a while before operations can be made. Wait for 15 seconds or longer, and then try again.
- Make sure the devices connected to the system support the Control for HDMI function.

- Enable the Control for HDMI function on the devices connected to the system. For details, refer to the operating instructions of your device.
- The type and number of devices that can be controlled by the Control for HDMI function is restricted by the HDMI CEC standard as follows:
 - Recording devices (Blu-ray Disc recorder, DVD recorder, etc.): up to 3 devices
 - Playback devices (Blu-ray Disc Player, DVD player, etc.): up to 3 devices
 - Tuner-related devices: up to 4 devices
 - Audio system (receiver/headphone): up to 1 device (used by this system)

“PRTCT,” “PUSH” and “POWER” flash alternately in the front panel display.

- Press  (power) to turn off the system. After the indicator disappears, disconnect the AC power cord (mains lead) and make sure nothing is obstructing the ventilation holes of the system.

“BT TX” appears in the front panel display.

- Press RX/TX on the remote control to switch [Bluetooth Mode] to [Receiver]. “BT TX” appears if [Bluetooth Mode] is set to [Transmitter] (page 50). When you press RX/TX on the remote control, [Bluetooth Mode] is switched to [Receiver] and the selected input appears in the front panel display.

Sensors of the TV do not work properly.

- The unit may block some sensors (such as the brightness sensor), the remote control receiver of your TV or the emitter for 3D glasses (infrared transmission) of a 3D TV that supports

the infrared 3D glass system, or wireless communication. Move the unit away from the TV within a range that allow those parts to operate properly. For the locations of the sensors and remote control receiver, refer to the operating instructions supplied with the TV.

Wireless functions (wireless LAN, BLUETOOTH, or subwoofer) are unstable.

- Do not place metal objects other than a TV around the system.

Resetting the System

If the system still does not operate properly, reset the system as follows.

- 1 Press HOME.**
The home menu appears on the TV screen.
- 2 Select  [Setup] from the home menu.**
The setup display appears on the TV screen.
- 3 Select [Resetting] - [Reset to Factory Default Settings].**
- 4 Select the menu item you want to reset.**
- 5 Select [Start].**

To cancel resetting

Select [Cancel] in step 5.

Note

By resetting, the link with the subwoofer may be lost. In this case, perform "Performing the Wireless Connection of the Subwoofer (LINK)" (page 40).

Additional Information

Specifications

Bar Speaker (SA-CT790)

Amplifier section

POWER OUTPUT (rated)

Front L + Front R:

50 W + 50 W (at 4 ohms, 1 kHz, 1%

THD)

POWER OUTPUT (reference)

Front L/Front R speaker blocks: 110 W
(per channel at 4 ohms, 1 kHz)

Inputs

HDMI IN 1/2/3*

ANALOG IN

TV IN (OPTICAL)

Outputs

HDMI OUT (TV (ARC))*

- * HDMI IN 1/2/3 and HDMI OUT (TV (ARC)) jacks support HDCP 2.2 protocol. HDCP 2.2 is newly enhanced copyright protection technology that is used to protect content such as 4K movies.

HDMI Section

Connector

Type A (19pin)

USB section

↓ (USB) port:

Type A (For connecting USB memory, memory card reader, digital still camera)

LAN section

LAN(100) terminal

100BASE-TX Terminal

Wireless LAN section

Communication system

IEEE 802.11 a/b/g/n

Frequency band

2.4 GHz, 5 GHz

BLUETOOTH section

Communication system

BLUETOOTH Specification version 4.1

Output

BLUETOOTH Specification Power Class 1

Maximum communication range

Line of sight approx. 30 m¹⁾

Maximum number of devices to be registered
9 devices

Frequency band

2.4 GHz band (2.4 GHz - 2.4835 GHz)

Modulation method

FHSS (Freq Hopping Spread Spectrum)

Compatible BLUETOOTH profiles²⁾

A2DP 1.2 (Advanced Audio Distribution Profile)

AVRCP 1.5 (Audio Video Remote Control Profile)

Supported Codecs³⁾

SBC⁴⁾, AAC⁵⁾, LDAC

Transmission range (A2DP)

20 Hz - 40,000 Hz (LDAC sampling frequency 96 kHz with 990 kbps transmission)

20 Hz - 20,000 Hz (Sampling frequency 44.1 kHz)

- 1) The actual range will vary depending on factors such as obstacles between devices, magnetic fields around a microwave oven, static electricity, cordless phone use, reception sensitivity, the operating system, software applications, etc.
- 2) BLUETOOTH standard profiles indicate the purpose of BLUETOOTH communication between devices.
- 3) Codec: Audio signal compression and conversion format
- 4) Abbreviation for Subband Codec
- 5) Abbreviation for Advanced Audio Coding

Front L/Front R speaker block section

Speaker system

Full range speaker system, Acoustic suspension

Speaker

60 mm cone type

General

Power requirements

220 V - 240 V AC, 50 Hz/60 Hz

Power consumption

On: 42 W

Standby mode: 0.5 W or less (For details on the setting, see page 43)

[Quick Start/Network Standby] is set to

[Off] (default setting): 3 W
[Quick Start/Network Standby] is set to
[On] (all wired network ports
connected, all wireless network ports
activated): 7 W

Dimensions* (approx.) (w/h/d)
1,030 mm × 52 mm × 126 mm
(without wall mounting brackets)
1,030 mm × 120 mm × 68.5 mm
(with wall mounting brackets)

* Not including projection portion

Mass (approx.)
2.8 kg

Compatible iPod/iPhone models

The compatible iPod/iPhone models are as follows. Update your iPod/iPhone with the latest software before using with the system.

BLUETOOTH technology works with:
iPhone 6s Plus/iPhone 6s/iPhone 6 Plus/
iPhone 6/iPhone 5s/iPhone 5c/iPhone 5/
iPhone 4s/iPhone 4
iPod touch (6th generation)/iPod touch
(5th generation)

Subwoofer (SA-WCT790)

POWER OUTPUT (reference)
110 W (at 4 ohms, 100 Hz)

Speaker system
Subwoofer speaker system, Bass
reflex
16 cm cone type

Power requirements
220 V - 240 V AC, 50 Hz/60 Hz

Power consumption
On: 25 W
Standby mode: 0.5 W or less

Dimensions (approx.) (w/h/d)
190 mm × 382 mm × 386 mm (not
including projection portion)

Mass (approx.)
7.8 kg

Wireless transmitter/ receiver section

Speaker system
Wireless Sound Specification version
2.0

Frequency band
2.4 GHz (2.4000 GHz - 2.4835 GHz)

Modulation method
Pi/4 DQPSK

Design and specifications are subject to
change without notice.

Playable Types of Files

Music

Codec	Extension
MP3 (MPEG-1 Audio Layer III)¹⁾	.mp3
AAC/HE-AAC^{1),2)}	.m4a, .aac ³⁾ , .mp4, .3gp
WMA9 Standard²⁾	.wma
WMA10 Pro⁷⁾	.wma
LPCM¹⁾	.wav
FLAC²⁾	.flac, .fla
Dolby Digital^{1),3)}	.ac3
DSF²⁾	.dsf
DSDIFF^{2),4)}	.dff
AIFF²⁾	.aiff, .aif
ALAC²⁾	.m4a
Vorbis	.ogg
Monkey's Audio	.ape

Photo

Format	Extension
JPEG	.jpeg, .jpg, .jpe
PNG⁵⁾	.png
GIF⁵⁾	.gif
BMP^{3),6)}	.bmp

¹⁾ The system can play ".mka" files. These files cannot be played on a home network server.

²⁾ The system may not play this file format on a home network server.

³⁾ The system does not play this file format on a home network server.

⁴⁾ The system does not play DST encoded files.

⁵⁾ The system does not play animated PNG or animated GIF files.

⁶⁾ The system does not play 16bit BMP files.

⁷⁾ The system does not play Lossless coded files.

Notes

- Some files may not play depending on the file format, the file encoding, the recording condition, or the home network server condition.
- Some files edited on a PC may not play.
- Fast forward or fast reverse may not be available with some files.
- The system does not play coded files such as DRM.
- The system can recognize the following files or folders in USB devices:
 - up to folders in the 9th layer (including the root folder)
 - up to 500 files/folders in a single layer
- The system can recognize the following files or folders stored in the home network server:
 - up to folders in the 19th layer
 - up to 999 files/folders in a single layer
- Some USB devices may not work with this system.
- The system can recognize Mass Storage Class (MSC) devices (such as flash memory or an HDD), Still Image Capture Devices (SICDs), and 101-key keyboards.

Supported Input Audio Formats

Audio formats supported by this system are as follows.

Format	Function	
	"HDMI1" "HDMI2" "HDMI3"	"TV" (DIGITAL IN)
LPCM 2ch	○	○
LPCM 5.1ch	○	-
LPCM 7.1ch	○	-
Dolby Digital	○	○
Dolby TrueHD, Dolby Digital Plus	○	-
DTS	○	○
DTS-ES Discrete 6.1, DTS-ES Matrix 6.1	○	○
DTS96/24	○	○
DTS-HD High Resolution Audio	○	-
DTS-HD Master Audio	○	-
DTS-HD LBR	○	-
DSD	○	-

○: Supported format.

-: Unsupported format.

Note

The HDMI IN 1/2/3 jacks do not support audio format that contains copy protections, such as Super Audio CD or DVD-Audio.

Supported Input Video Formats

Video formats supported by this system are as follows.

Format	Frame Rate	Color Space	HDMI cable		HDMI Signal Format	
			Premium High Speed HDMI Cable with Ethernet	High Speed HDMI Cable with Ethernet	Enhanced	Normal
4096/3840 × 2160p 4K	50/59.94/60 Hz	RGB YCbCr444/422	⊙	○	○	-
		YCbCr420	⊙	○	○	-
	23.98/24/25/29.97/30 Hz	RGB YCbCr444/422	○	○	○	○
			○	○	○	○
1920 × 1080p	23.98/24/25/30/50/59.94/60 Hz	RGB YCbCr444/422	○	○	○	○
1920 × 1080i	50/59.94/60 Hz		○	○	○	○
1280 × 720p	23.98/24/29.97/30/50/59.94/60 Hz		○	○	○	○
720 × 480p	59.94/60 Hz		○	○	○	○
720 × 576p	50 Hz		○	○	○	○
640 × 480p	59.94/60 Hz		RGB	○	○	○

⊙: Recommended/○: Supported/-: Unsupported

- All HDMI IN and HDMI OUT jacks support bandwidth up to 18Gbps, HDCP 2.2, ITU-R BT.2020 wide color spaces, and HDR (High Dynamic Range) contents pass-through.
- HDCP 2.2 is newly enhanced copyright protection technology that is used to protect content such as 4K movies.
- ITU-R BT.2020 color space is new wider color standard that is defined for ultra-high definition television systems.
- HDR is an emerging video format that can display a wider range of brightness levels.

On BLUETOOTH Communication

- BLUETOOTH devices should be used within approximately 10 meters (33 feet) (unobstructed distance) of each other. The effective communication range may become shorter under the following conditions:
 - When a person, metal object, wall or other obstruction is between the devices with a BLUETOOTH connection
 - Locations where a wireless LAN is installed
 - Around microwave ovens that are in use
 - Locations where other electromagnetic waves occur
- BLUETOOTH devices and wireless LAN (IEEE 802.11 b/g/n) use the same frequency band (2.4 GHz). When using your BLUETOOTH device near a device with wireless LAN capability, electromagnetic interference may occur. This could result in lower data transfer rates, noise, or inability to connect. If this happens, try the following remedies:
 - Use this system at least 10 meters (33 feet) away from the wireless LAN device.
 - Turn off the power to the wireless LAN device when using your BLUETOOTH device within 10 meters (33 feet).
 - Install this system and BLUETOOTH device as close to each other as possible.
- The radio waves broadcast by this system may interfere with the operation of some medical devices. Since this interference may result in malfunction, always turn off the power on this system and BLUETOOTH device in the following locations:
 - In hospitals, on trains, in airplanes, at gas stations, and any place where flammable gasses may be present
 - Near automatic doors or fire alarms
- This system supports security functions that comply with the BLUETOOTH specification to ensure secure connection

during communication using BLUETOOTH technology. However, this security may be insufficient depending on the setting content and other factors, so always be careful when performing communication using BLUETOOTH technology.

- Sony cannot be held liable in any way for damages or other loss resulting from information leaks during communication using BLUETOOTH technology.
- BLUETOOTH communication is not necessarily guaranteed with all BLUETOOTH devices that have the same profile as this system.
- BLUETOOTH devices connected with this system must comply with the BLUETOOTH specification prescribed by the Bluetooth SIG, Inc., and must be certified to comply. However, even when a device complies with the BLUETOOTH specification, there may be cases where the characteristics or specifications of the BLUETOOTH device make it impossible to connect, or may result in different control methods, display or operation.
- Noise may occur or the audio may cut off depending on the BLUETOOTH device connected with this system, the communications environment, or surrounding conditions.

If you have any questions or problems concerning your system, please consult your nearest Sony dealer.

END USER LICENSE AGREEMENT

IMPORTANT:

BEFORE USING THE SOFTWARE, PLEASE READ THIS END USER LICENSE AGREEMENT (“EULA”) CAREFULLY. BY USING THE SOFTWARE YOU ARE ACCEPTING THE TERMS OF THIS EULA. IF YOU DO NOT ACCEPT THE TERMS OF THIS EULA, YOU MAY NOT USE THE SOFTWARE.

This EULA is a legal agreement between you and Sony Corporation (“SONY”). This EULA governs your rights and obligations regarding the SONY software of SONY and/or its third party licensors (including SONY’s affiliates) and their respective affiliates (collectively, the “THIRD-PARTY SUPPLIERS”), together with any updates/upgrades provided by SONY, any printed, on-line or other electronic documentation for such software, and any data files created by operation of such software (collectively, the “SOFTWARE”).

Notwithstanding the foregoing, any software in the SOFTWARE having a separate end user license agreement (including, but not limited to, GNU General Public license and Lesser/Library General Public License) shall be covered by such applicable separate end user license agreement in lieu of the terms of this EULA to the extent required by such separate end user license agreement (“EXCLUDED SOFTWARE”).

SOFTWARE LICENSE

The SOFTWARE is licensed, not sold. The SOFTWARE is protected by copyright and other intellectual property laws and international treaties.

COPYRIGHT

All right and title in and to the SOFTWARE (including, but not limited to, any images, photographs, animation, video, audio, music, text and “applets” incorporated into the SOFTWARE) is owned by SONY or one or more of the THIRD-PARTY SUPPLIERS.

GRANT OF LICENSE

SONY grants you a limited license to use the SOFTWARE solely in connection with your compatible device (“DEVICE”) and only for your individual, non-commercial use. SONY and the THIRD-PARTY SUPPLIERS expressly reserve all rights, title and interest (including, but not limited to, all intellectual property rights) in and to the SOFTWARE that this EULA does not specifically grant to you.

REQUIREMENTS AND LIMITATIONS

You may not copy, publish, adapt, redistribute, attempt to derive source code, modify, reverse engineer, decompile, or disassemble any of the SOFTWARE, whether in whole or in part, or create any derivative works from or of the SOFTWARE unless such derivative works are intentionally facilitated by the SOFTWARE. You may not modify or tamper with any digital rights management functionality of the SOFTWARE. You may not bypass, modify, defeat or circumvent any of the functions or protections of the SOFTWARE or any mechanisms operatively linked to the SOFTWARE. You may not separate any individual component of the SOFTWARE for use on more than one DEVICE unless expressly authorized to do so by SONY. You may not remove, alter, cover or deface any trademarks or notices on the SOFTWARE. You may not share, distribute, rent, lease, sublicense, assign, transfer or sell the SOFTWARE.

The software, network services or other products other than SOFTWARE upon which the SOFTWARE'S performance depends might be interrupted or discontinued at the discretion of the suppliers (software suppliers, service suppliers, or SONY). SONY and such suppliers do not warrant that the SOFTWARE, network services, contents or other products will continue to be available, or will operate without interruption or modification.

USE OF SOFTWARE WITH COPYRIGHTED MATERIALS

The SOFTWARE may be capable of being used by you to view, store, process and/or use content created by you and/or third parties. Such content may be protected by copyright, other intellectual property laws, and/or agreements. You agree to use the SOFTWARE only in compliance with all such laws and agreements that apply to such content. You acknowledge and agree that SONY may take appropriate measures to protect the copyright of content stored, processed or used by the SOFTWARE. Such measures include, but are not limited to, counting the frequency of your backup and restoration through certain SOFTWARE features, refusal to accept your request to enable restoration of data, and termination of this EULA in the event of your illegitimate use of the SOFTWARE.

CONTENT SERVICE

PLEASE ALSO NOTE THAT THE SOFTWARE MAY BE DESIGNED TO BE USED WITH CONTENT AVAILABLE THROUGH ONE OR MORE CONTENT SERVICES ("CONTENT SERVICE"). USE OF THE SERVICE AND THAT CONTENT IS SUBJECT TO THE TERMS OF SERVICE OF THAT CONTENT SERVICE. IF YOU DECLINE TO ACCEPT THOSE TERMS, YOUR USE OF THE SOFTWARE WILL BE LIMITED. You acknowledge and agree

that certain content and services available through the SOFTWARE may be provided by third parties over which SONY has no control. USE OF THE CONTENT SERVICE REQUIRES AN INTERNET CONNECTION. THE CONTENT SERVICE MAY BE DISCONTINUED AT ANY TIME.

INTERNET CONNECTIVITY AND THIRD PARTY SERVICES

You acknowledge and agree that access to certain SOFTWARE features may require an Internet connection for which you are solely responsible. Further, you are solely responsible for payment of any third party fees associated with your Internet connection, including but not limited to Internet service provider or airtime charges. Operation of the SOFTWARE may be limited or restricted depending on the capabilities, bandwidth or technical limitations of your Internet connection and service. The provision, quality and security of such Internet connectivity are the sole responsibility of the third party providing such service.

EXPORT AND OTHER REGULATIONS

You agree to comply with all applicable export and re-export restrictions and regulations of the area or country in which you reside, and not to transfer, or authorize the transfer, of the SOFTWARE to a prohibited country or otherwise in violation of any such restrictions or regulations.

HIGH RISK ACTIVITIES

The SOFTWARE is not fault-tolerant and is not designed, manufactured or intended for use or resale as on-line control equipment in hazardous environments requiring fail-safe performance, such as in the operation of nuclear facilities, aircraft navigation or communication systems, air traffic

control, direct life support machines, or weapons systems, in which the failure of the SOFTWARE could lead to death, personal injury, or severe physical or environmental damage ("HIGH RISK ACTIVITIES"). SONY, each of the THIRD-PARTY SUPPLIERS, and each of their respective affiliates specifically disclaim any express or implied warranty, duty or condition of fitness for HIGH RISK ACTIVITIES.

EXCLUSION OF WARRANTY ON SOFTWARE

You acknowledge and agree that use of the SOFTWARE is at your sole risk and that you are responsible for use of the SOFTWARE. The SOFTWARE is provided "AS IS," without warranty, duty or condition of any kind.

SONY AND EACH OF THE THIRD-PARTY SUPPLIERS (for purposes of this Section, SONY and each of the THIRD-PARTY SUPPLIERS shall be collectively referred to as "SONY") EXPRESSLY DISCLAIM ALL WARRANTIES, DUTIES OR CONDITIONS, EXPRESS OR IMPLIED, INCLUDING, BUT NOT LIMITED TO, THE IMPLIED WARRANTIES OF MERCHANTABILITY, NONINFRINGEMENT AND FITNESS FOR A PARTICULAR PURPOSE. SONY DOES NOT WARRANT OR MAKE ANY CONDITIONS OR REPRESENTATIONS (A) THAT THE FUNCTIONS CONTAINED IN ANY OF THE SOFTWARE WILL MEET YOUR REQUIREMENTS OR THAT THEY WILL BE UPDATED, (B) THAT THE OPERATION OF ANY OF THE SOFTWARE WILL BE CORRECT OR ERROR-FREE OR THAT ANY DEFECTS WILL BE CORRECTED, (C) THAT THE SOFTWARE WILL NOT DAMAGE ANY OTHER SOFTWARE, HARDWARE OR DATA, (D) THAT ANY SOFTWARE, NETWORK SERVICES (INCLUDING THE INTERNET) OR PRODUCTS (OTHER THAN THE SOFTWARE) UPON WHICH THE SOFTWARE'S PERFORMANCE DEPENDS WILL CONTINUE TO BE AVAILABLE,

UNINTERRUPTED OR UNMODIFIED, AND (E) REGARDING THE USE OR THE RESULTS OF THE USE OF THE SOFTWARE IN TERMS OF ITS CORRECTNESS, ACCURACY, RELIABILITY, OR OTHERWISE.

NO ORAL OR WRITTEN INFORMATION OR ADVICE GIVEN BY SONY OR AN AUTHORIZED REPRESENTATIVE OF SONY SHALL CREATE A WARRANTY, DUTY OR CONDITION OR IN ANY WAY INCREASE THE SCOPE OF THIS WARRANTY. SHOULD THE SOFTWARE PROVE DEFECTIVE YOU ASSUME THE ENTIRE COST OF ALL NECESSARY SERVICING, REPAIR OR CORRECTION. SOME JURISDICTIONS DO NOT ALLOW THE EXCLUSION OF IMPLIED WARRANTIES, SO THESE EXCLUSIONS MAY NOT APPLY TO YOU.

LIMITATION OF LIABILITY

SONY AND EACH OF THE THIRD-PARTY SUPPLIERS (for purposes of this Section, SONY and each of the THIRD-PARTY SUPPLIERS shall be collectively referred to as "SONY") SHALL NOT BE LIABLE FOR ANY INCIDENTAL OR CONSEQUENTIAL DAMAGES FOR BREACH OF ANY EXPRESS OR IMPLIED WARRANTY, BREACH OF CONTRACT, NEGLIGENCE, STRICT LIABILITY OR UNDER ANY OTHER LEGAL THEORY RELATED TO THE SOFTWARE, INCLUDING, BUT NOT LIMITED TO, ANY DAMAGES ARISING OUT OF LOSS OF PROFITS, LOSS OF REVENUE, LOSS OF DATA, LOSS OF USE OF THE SOFTWARE OR ANY ASSOCIATED HARDWARE, DOWN TIME AND USER'S TIME, EVEN IF ANY OF THEM HAVE BEEN ADVISED OF THE POSSIBILITY OF SUCH DAMAGES. IN ANY CASE, EACH AND ALL OF THEIR AGGREGATE LIABILITY UNDER ANY PROVISION OF THIS EULA SHALL BE LIMITED TO THE AMOUNT ACTUALLY PAID FOR THE PRODUCT. SOME JURISDICTIONS DO NOT ALLOW THE EXCLUSION OR LIMITATION OF INCIDENTAL OR CONSEQUENTIAL

DAMAGES, SO THE ABOVE EXCLUSION OR LIMITATION MAY NOT APPLY TO YOU.

AUTOMATIC UPDATE FEATURE

From time to time, SONY or the THIRD-PARTY SUPPLIERS may automatically update or otherwise modify the SOFTWARE, including, but not limited to, for purposes of enhancement of security functions, error correction and improvement of functions, at such time as you interact with SONY's or third parties' servers, or otherwise. Such updates or modifications may delete or change the nature of features or other aspects of the SOFTWARE, including, but not limited to, functions you may rely upon. You acknowledge and agree that such activities may occur at SONY's sole discretion and that SONY may condition continued use of the SOFTWARE upon your complete installation or acceptance of such update or modifications. Any updates/modifications shall be deemed to be, and shall constitute part of, the SOFTWARE for purposes of this EULA. By acceptance of this EULA, you consent to such update/modification.

ENTIRE AGREEMENT, WAIVER, SEVERABILITY

This EULA and SONY's privacy policy, each as amended and modified from time to time, together constitute the entire agreement between you and SONY with respect to the SOFTWARE. The failure of SONY to exercise or enforce any right or provision of this EULA shall not constitute a waiver of such right or provision. If any part of this EULA is held invalid, illegal, or unenforceable, that provision shall be enforced to the maximum extent permissible so as to maintain the intent of this EULA, and the other parts will remain in full force and effect.

GOVERNING LAW AND JURISDICTION

The United Nations Convention on Contracts for the International Sale of Goods shall not apply to this EULA. This EULA shall be governed by the laws of Japan, without regards to conflict of laws provisions. Any dispute arising out of this EULA shall be subject to the exclusive venue of the Tokyo District Court in Japan, and the parties hereby consent to the venue and jurisdiction of such courts.

EQUITABLE REMEDIES

Notwithstanding anything contained in this EULA to the contrary, you acknowledge and agree that any violation of or non-compliance with this EULA by you will cause irreparable harm to SONY, for which monetary damages would be inadequate, and you consent to SONY obtaining any injunctive or equitable relief that SONY deems necessary or appropriate in such circumstances. SONY may also take any legal and technical remedies to prevent violation of and/or to enforce this EULA, including, but not limited to, immediate termination of your use of the SOFTWARE, if SONY believes in its sole discretion that you are violating or intend to violate this EULA. These remedies are in addition to any other remedies SONY may have at law, in equity or under contract.

TERMINATION

Without prejudice to any of its other rights, SONY may terminate this EULA if you fail to comply with any of its terms. In case of such termination, you must cease all use, and destroy any copies, of the SOFTWARE.

AMENDMENT

SONY RESERVES THE RIGHT TO AMEND ANY OF THE TERMS OF THIS EULA AT ITS

SOLE DISCRETION BY POSTING NOTICE ON A SONY DESIGNATED WEB SITE, BY EMAIL NOTIFICATION TO AN EMAIL ADDRESS PROVIDED BY YOU, BY PROVIDING NOTICE AS PART OF THE PROCESS IN WHICH YOU OBTAIN UPGRADES/UPDATES OR BY ANY OTHER LEGALLY RECOGNIZABLE FORM OF NOTICE. If you do not agree to the amendment, you should promptly contact SONY for instructions. Your continued use of the SOFTWARE after the effective date of any such notice shall be deemed your agreement to be bound by such amendment.

THIRD-PARTY BENEFICIARIES

Each THIRD-PARTY SUPPLIER is an express intended third-party beneficiary of, and shall have the right to enforce, each provision of this EULA with respect to the SOFTWARE of such party.

Should you have any questions concerning this EULA, you may contact SONY by writing to SONY at applicable contact address of each area or country.

Copyright © 2014 Sony Corporation.

Precautions

On safety

- Should any solid object or liquid fall into the system, unplug the system and have it checked by qualified personnel before operating it any further.
- Do not climb on the unit and subwoofer, as you may fall down and injure yourself, or system damage may result.

On power sources

- Before operating the system, check that the operating voltage is identical to your local power supply. The operating voltage is indicated on the nameplate at the bottom of the unit.
- If you are not going to use the system for a long time, be sure to disconnect the system from the wall outlet (mains). To disconnect the AC power cord (mains lead), grasp the plug itself; never pull the cord.
- One blade of the plug is wider than the other for the purpose of safety and will fit into the wall outlet (mains) only one way. If you are unable to insert the plug fully into the outlet, contact your dealer.
- AC power cord (mains lead) must be changed only at a qualified service shop.

On heat buildup

Although the system heats up during operation, this is not a malfunction. If you continuously use this system at high volume, the system temperature at the rear and bottom rises considerably. To avoid burning yourself, do not touch the system.

On placement

- Do not place the system near heat sources or in a place subject to direct sunlight, excessive dust, or mechanical shock.
- Do not place anything at the rear of the unit and subwoofer that might block the ventilation holes and cause malfunctions.

- Do not place metal objects other than a TV around the system. Wireless functions may be unstable.
- If the system is being used in combination with a TV, VCR, or tape deck, noise may result and picture quality may suffer. In such a case, place the system away from the TV, VCR, or tape deck.
- Use caution when placing the system on a surface that has been specially treated (with wax, oil, polish, etc.), as staining or discoloration of the surface may result.
- Take care to avoid any possible injury from the corners of the unit and subwoofer.
- Keep 3 cm or more space under the unit when you hang it on a wall.
- The speakers of this system are not of magnetically shielded type. Do not place magnetic cards on the system or near it.

On handling the subwoofer

Do not place your hand into the slit of the subwoofer when lifting it. The speaker driver may be damaged. When lifting it, hold the bottom of the subwoofer.

On operation

Before connecting other devices, be sure to turn off and unplug the system.

If you encounter color irregularity on a nearby TV screen

Color irregularities may be observed on certain types of TV sets.

If color irregularity is observed...

Turn off the TV set, then turn it on again after 15 to 30 minutes.

If color irregularity is observed again...

Place the system further away from the TV set.

On cleaning

Clean the system with a soft, dry cloth. Do not use any type of abrasive pad, scouring powder, or solvent such as alcohol or benzene.

If you have any question or problem concerning your system, please consult your nearest Sony dealer.

Disclaimer regarding services offered by third parties

Services offered by third parties may be changed, suspended, or terminated without prior notice. Sony does not bear any responsibility in these sorts of situations.

Notes on updating

This system allows you to update the software automatically when connected to the Internet via a wired or wireless network.

You can add new features and use the system with more convenience and safety by updating the system.

If you do not want to update automatically, you can disable the function by using SongPal installed on your smartphone or tablet. However, the system may update the software automatically for reasons such as safety, even if this function is disabled. You can also update the software using the settings menu when this function is disabled. Refer to "Using the Setup Display" (page 48) for details.

You may not use the system while the software is being updated.

Copyrights and Trademarks

This system incorporates Dolby* Digital and the DTS** Digital Surround System.

* Manufactured under license from Dolby Laboratories.

Dolby and the double-D symbol are trademarks of Dolby Laboratories.

**For DTS patents, see <http://patents.dts.com>. Manufactured under license from DTS Licensing Limited. DTS, DTS-HD, the Symbol, & DTS and the Symbol together are registered trademarks of DTS, Inc. © DTS, Inc. All Rights Reserved.

The BLUETOOTH® word mark and logos are registered trademarks owned by Bluetooth SIG, Inc. and any use of such marks by Sony Corporation is under license. Other trademarks and trade names are those of their respective owners.

This system incorporates High-Definition Multimedia Interface (HDMI™) technology. The terms HDMI and HDMI High-Definition Multimedia Interface, and the HDMI Logo are trademarks or registered trademarks of HDMI Licensing LLC in the United States and other countries.

The N Mark is a trademark or registered trademark of NFC Forum, Inc. in the United States and in other countries.

Android and Google Play are trademarks of Google Inc.

Google Cast and the Google Cast badge are trademarks of Google Inc.

“Xperia” is a trademark of Sony Mobile Communications AB.

Apple, the Apple logo, iPhone, iPod, iPod touch, and Retina are trademarks of Apple Inc., registered in the U.S. and other countries. App Store is a service mark of Apple Inc.

“Made for iPod,” and “Made for iPhone” mean that an electronic accessory has been designed to connect specifically to iPod or iPhone, respectively, and has been certified by the developer to meet Apple performance standards. Apple is not responsible for the operation of this device or its compliance with safety and regulatory standards. Please note that the use of this accessory with iPod or iPhone may affect wireless performance.

“BRAVIA” logo is a trademark of Sony Corporation.

“ClearAudio+” is a trademark of Sony Corporation.

“PlayStation” is a registered trademark of Sony Computer Entertainment Inc.

MPEG Layer-3 audio coding technology and patents licensed from Fraunhofer IIS and Thomson.

Windows Media is either a registered trademark or trademark of Microsoft Corporation in the United States and/or other countries.

This product is protected by certain intellectual property rights of Microsoft Corporation. Use or distribution of such technology outside of this product is prohibited without a license from Microsoft or an authorized Microsoft subsidiary.

Opera® Devices SDK from Opera Software ASA. Copyright 1995-2015 Opera Software ASA. All rights reserved.



Wi-Fi®, Wi-Fi Protected Access®, Wi-Fi Alliance® and Wi-Fi CERTIFIED Miracast® are registered trademarks of Wi-Fi Alliance.

Wi-Fi CERTIFIED™, WPA™, WPA2™, Wi-Fi Protected Setup™ and Miracast™ are trademarks of Wi-Fi Alliance.

LDAC™ and LDAC logo are trademarks of Sony Corporation.

LDAC is an audio coding technology developed by Sony that enables the transmission of High-Resolution (Hi-Res) Audio content, even over a Bluetooth connection. Unlike other Bluetooth compatible coding technologies such as SBC, it operates without any down-conversion of the Hi-Res Audio content*, and allows approximately three times more data** than those other technologies to be transmitted over a Bluetooth wireless network with unprecedented sound quality, by means of efficient coding and optimized packetization.

* excluding DSD format contents

**in comparison with SBC (Subband Coding) when the bitrate of 990 kbps (96/48 kHz) or 909 kbps (88.2/44.1 kHz) is selected

This product contains software that is subject to the GNU General Public License ("GPL") or GNU Lesser General Public License ("LGPL"). These establish that customers have the right to acquire, modify, and redistribute the source code of said software in accordance with the terms of the GPL or the LGPL.

For details of the GPL, LGPL and other software licenses, please refer to [Software License Information] in [System Settings] of the [Setup] menu on the product.

The source code for the software used in this product is subject to the GPL and LGPL, and is available on the Web. To download, please access the following:

URL:

<http://oss.sony.net/Products/Linux>

Please note that Sony cannot answer or respond to any inquiries regarding the content of this source code.

"DSEE" is a trademark of Sony Corporation.

DLNA™, the DLNA Logo and DLNA CERTIFIED™ are trademarks, service marks, or certification marks of the Digital Living Network Alliance.

"TRILUMINOS" and "TRILUMINOS" logo are a registered trademark of Sony Corporation.

This product incorporates Spotify software which is subject to 3rd party licenses found here*:

<https://developer.spotify.com/esdk-third-party-licenses/>

Spotify and Spotify logos are trademarks of the Spotify Group.*

* Depending on the country and region, this function may not be available.

All other trademarks are trademarks of their respective owners.

Index

Numerics

24p Output 49

4K Output 49

A

Attenuation settings - Analog 50

Audio DRC 50

Audio Output 50

Audio Return Channel 52

Audio Settings 50

Auto Display 53

Auto Home Network Access
Permission 54

Auto Standby 53

Auto Update 53

Auto Update Settings 53

B

Bluetooth Codec - AAC 51

Bluetooth Codec - LDAC 51

Bluetooth Mode 50

Bluetooth Settings 50

Bluetooth Standby 51

C

Connection Server Settings 54

Control for HDMI 52

D

Device List 51

Device Name 53

DSEE 50

E

Easy Setup 55

External Control 54

G

Google Cast 37

H

HDMI

YCbCr/RGB (HDMI) 50

HDMI Settings 52

HDMI Signal Format 52

HDMI1 Audio Input Mode 52

Home Network Access Control 54

I

Initialize Personal Information 55

Input Skip Setting 54

Internet Settings 54

M

Multiplex broadcast sound 41

N

Network 18, 39

Network Connection Diagnostics 54

Network Connection Status 54

Network content 24p Output 49

Network Settings 54

NFC 30

O

OSD Language 52

Output Video Resolution 49

P

PRTCT 63

Q

Quick Start/Network Standby 53

R

Remote control 10

Remote Start 54

Reset to Factory Default Settings 55

Resetting 55

S

SBM 50

Screen mirroring RF Setting 54

Screen Settings 49

Slideshow 56

Software License Information 53

Software Update 49

Software Update Notification 53

Sound field 56

Standby Through 52
System Information 53
System Settings 52

T

Time Zone 53
TV Type 49

U

Update 49

V

Video Direct 50

W

Wireless Playback Quality 51
Wireless Subwoofer Connection 52

The software of this system may be updated in the future. To find out details on any available updates, please visit the following URL.
www.sony.eu/support



* 4 5 8 6 0 5 0 7 2 * (1)