

Digital Music Player
NWZ-B183/B183F



Use this manual when you have troubles or when you need to know how to use your WALKMAN®.

How to Use

[Getting Started](#) >

[Basic Operations](#) >

[Transferring Content](#) >

[Music](#) >

[FM Radio](#) >

[Settings](#) >

[Announcement](#) >

[Specifications](#) >

Troubleshooting

[Troubleshooting](#) >

[Q&A](#)



 [List of Topics](#)

[How to Use](#)



[Troubleshooting](#)



[Notes on use](#)

4-529-726-11(1)

Copyright 2014 Sony Corporation

Digital Music Player
NWZ-B183/B183F

Getting Started

[Customer Registration Website](#)



[Before Use](#)



[Enjoying Using Your Walkman](#)



[Parts and Controls](#)



[Power/Charging](#)



[Initial Settings](#)



[Notes on use](#)

4-529-726-11(1)

Copyright 2014 Sony Corporation

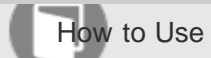

Digital Music Player
NWZ-B183/B183F

Basic Operations

[Home Menu](#)



[Connecting Your Walkman to Your Computer](#)



[Initializing/Updating](#)



[Notes on use](#)

4-529-726-11(1)

Copyright 2014 Sony Corporation

Digital Music Player
NWZ-B183/B183F

Transferring Content

[Importing Content to the Software](#)



[Transferring Content to Your Walkman](#)



[Deleting Content from Your Walkman](#)



[Notes on use](#)

4-529-726-11(1)

Copyright 2014 Sony Corporation



Digital Music Player
NWZ-B183/B183F

Music

[Playing Music](#)



[Deleting Songs](#)



[Music Settings](#)



[Notes on use](#)

4-529-726-11(1)

Copyright 2014 Sony Corporation



Digital Music Player
NWZ-B183/B183F

FM Radio

[Listening to FM Radio](#)



[FM Radio Settings](#)



[FM Radio Recording](#)



[Notes on use](#)

4-529-726-11(1)

Copyright 2014 Sony Corporation



Digital Music Player
NWZ-B183/B183F

Settings

[Music Settings](#) 

[FM Radio Settings](#) 

[Common Settings](#) 

[Unit Information](#) 

[Language Settings](#) 

[Reset/Format](#) 

[Notes on use](#)

4-529-726-11(1)

Copyright 2014 Sony Corporation



Digital Music Player
NWZ-B183/B183F

Announcement

[Precautions](#)



[Customer Support Website](#)



[Notes on use](#)

4-529-726-11(1)

Copyright 2014 Sony Corporation

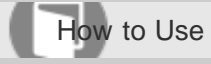

Digital Music Player
NWZ-B183/B183F

Specifications

[Specifications](#)



[Notes on use](#)

4-529-726-11(1)

Copyright 2014 Sony Corporation



Digital Music Player
NWZ-B183/B183F

Troubleshooting

[What Can I Do to Solve a Problem?](#)



[Notes on use](#)

4-529-726-11(1)

Copyright 2014 Sony Corporation

Digital Music Player
NWZ-B183/B183F

Q&A

[Operation](#)



[Sound](#)



[Power](#)



[Connection to a Computer](#)



[Displaying/Playing/Deleting Content](#)



[Recordings](#)



[FM Radio](#)



[Other](#)



[Notes on use](#)

4-529-726-11(1)

Copyright 2014 Sony Corporation



Digital Music Player
NWZ-B183/B183F

How to Use

Getting Started

Customer Registration Website

- [Customer registration website](#)

Before Use

- [Before first use](#)
- [Walkman instruction manuals](#)

Enjoying Using Your Walkman

- [3 steps to listening to music](#)
- [Various ways to enjoy using your Walkman](#)

Parts and Controls

- [Parts and controls](#)

Power/Charging

- [Turning the power on](#)
- [Turning the power off](#)
- [Using the HOLD switch](#)
- [Charging the battery](#)
- [Extending the battery life](#)
- [Notes on charging the battery](#)

Initial Settings

- [Selecting the display language](#)

Basic Operations

Home Menu

- [How to use the Home menu](#)

Connecting Your Walkman to Your Computer

- [Connecting to a computer via USB](#)
- [Notes on USB connection](#)

Initializing/Updating

- [Resetting your Walkman](#)
- [Resetting to the factory settings](#)
- [Formatting memory](#)

- [Updating the firmware of your Walkman](#)

Transferring Content

Importing Content to the Software

- [Importing music from media using Windows Media Player](#)

Transferring Content to Your Walkman

- [Transferring content using Windows Media Player](#)
- [Transferring content using Explorer](#)
- [Notes for transferring content from your computer](#)

Deleting Content from Your Walkman

- [Deleting content from your Walkman using Explorer](#)

Music

Playing Music

- [Preparing music](#)
- [Playing music](#)
- [Volume operation \(Only for countries/areas complying with European and Korean Directives\)](#)
- [Browsing the music playback screen](#)
- [Music playback operations](#)

Deleting Songs

- [Deleting songs](#)

Music Settings

- [Shuffle playback](#)
- [Repeat playback](#)
- [Bass Boost settings](#)
- [Customizing sound quality settings](#)
- [Presetting your equalizer settings](#)

FM Radio

Listening to FM Radio

- [Listening to FM radio](#)
- [Browsing the FM radio screen](#)
- [FM radio operations](#)
- [Presetting broadcast stations automatically](#)
- [Presetting broadcast stations manually](#)
- [Deleting preset broadcast stations](#)

FM Radio Settings

- [Changing the FM radio scan sensitivity](#)
- [Presetting broadcast stations automatically](#)

FM Radio Recording

- [Making FM radio recordings](#)

- [Playing FM radio recordings](#)
- [Deleting FM radio recordings](#)

Settings

Music Settings

- [Shuffle playback](#)
- [Repeat playback](#)
- [Bass Boost settings](#)
- [Customizing sound quality settings](#)
- [Presetting your equalizer settings](#)

FM Radio Settings

- [Changing the FM radio scan sensitivity](#)
- [Presetting broadcast stations automatically](#)

Common Settings

- [Limiting the volume](#)
- [Setting the operation sound](#)
- [Setting the screen off timer](#)
- [Adjusting the screen brightness](#)

Unit Information

- [Displaying your Walkman information](#)

Language Settings

- [Selecting the display language](#)

Reset/Format

- [Resetting to the factory settings](#)
- [Formatting memory](#)

Announcement

Precautions

- [Warning](#)
- [Caution](#)
- [Notice for users](#)
- [Notes on headphones](#)
- [Notes on the software](#)

Customer Support Website

- [Customer support website](#)

Specifications

Specifications

- [Specifications](#)
- [Battery life](#)
- [Maximum recordable number of songs and time \(Approx.\)](#)

- [Maximum recordable time \(Approx.\)](#)
- [Supported formats](#)
- [System requirements](#)
- [Contents](#)

[Notes on use](#)

4-529-726-11(1)

Copyright 2014 Sony Corporation

Digital Music Player
NWZ-B183/B183F

Troubleshooting

Troubleshooting

What Can I Do to Solve a Problem?

- [What can I do to solve a problem?](#)
- [Customer support website](#)

Q&A

Operation

- [Your Walkman does not operate or the power does not turn on.](#)
- [Your Walkman does not work properly.](#)
- [Your Walkman power turns off or on automatically.](#)
- [I want my Walkman screen to stay on longer before it turns off automatically.](#)
- [A drink \(water, coffee, etc.\) was spilled on your Walkman, or the Walkman was washed in the washing machine.](#)
- [I want to backup the content such as music saved on my Walkman.](#)
- [I want to find the product name \(model name\) of my Walkman.](#)
- [An alarm \(beep\) is heard and the message \[Check the volume level\] is displayed.](#)

Sound

- [There is no sound.](#)
- [The content such as music suddenly stops during playback.](#)
- [Noise is generated.](#)
- [Volume cannot be turned up, or the volume remains low when the playback volume is turned up.](#)
- [Sound can only be heard from one side of the headphones.](#)
- [Sound is interrupted or skips.](#)

Power

- [Cannot charge the Walkman.](#)
- [What is the battery life of the built-in rechargeable battery?](#)
- [The rechargeable battery needs to be replaced.](#)
- [The battery duration is short.](#)
- [What is the standard battery duration?](#)
- [How long does it take to charge the battery?](#)

Connection to a Computer

- [The computer does not recognize your Walkman.](#)
- [Even if you use "Safely Remove Hardware" on the computer, \[Connecting USB\] remains displayed on your Walkman screen.](#)

- Content such as music cannot be transferred from the computer to your Walkman.
- Only a small amount of content such as music can be transferred to your Walkman.
- Your Walkman becomes unstable when it is connected to the computer.

Displaying/Playing/Deleting Content

- Cannot play content such as music transferred to your Walkman.
- Songs are not played back in the expected order.
- [□] is displayed in the screen.
- [Unknown] is displayed for the album name or artist name.
- Cannot delete content such as music using the Walkman functions.

Recordings

- The remaining recording time remains the same even though files are deleted.
- Cannot record.
- The combined total elapsed and remaining recording time does not equal the maximum recording time.
- A folder is not deleted even though all recorded files have been deleted.

FM Radio

- Cannot hear FM radio broadcasts.
- There is a lot of noise in the FM radio broadcast and the sound quality is poor.

Other

- Your Walkman gets warm.

Notes on use

4-529-726-11(1)

Copyright 2014 Sony Corporation



Before use

To make full use of this content, please read the following notes thoroughly. Please note that they are subject to change without prior notice.

Recommended system environment

The following system environments are recommended for displaying this content. You may not be able to view the content on other system environments.

For viewing on a computer

Recommended browser

- With Microsoft Windows
 - Microsoft Internet Explorer 8 or later
 - Mozilla Firefox: latest version
 - Google Chrome™ : latest version
- With Apple Mac OS
 - Apple Safari Ver. 5 or later
 - Mozilla Firefox: latest version
 - Google Chrome : latest version

For viewing on a smartphone or tablet

Basic operation has been confirmed on the standard browser for the noted devices running the following operating systems.

- Android™ 2.3 or later: Xperia series, Walkman running Android
- iOS 4 or later: iPhone, iPod touch, iPad

JavaScript

JavaScript is used with this content for viewing convenience. If JavaScript is disabled in your web browser settings, the content may not operate properly or it may not be displayed correctly.

Style Sheets

Cascading Style Sheets are used in designing this content. Page layout may not be as intended if you view the content with style sheets disabled or on a web browser that is not compatible with style sheets. However, operation will not be affected.

Cookies

This content uses cookies. To use services incorporating cookies, you need to set your browser to allow cookies.

Handling of personal information obtained from websites

Sony may use cookies, web beacons or similar technologies to make statistical analysis of customers' usage of this content while preserving anonymity.

Notes on use

4-529-726-11(1)

Copyright 2014 Sony Corporation



Digital Music Player
NWZ-B183/B183F

Customer Registration Website

[Customer registration website](#)

View information on websites where you can register your Walkman.



[Notes on use](#)

4-529-726-11(1)

Copyright 2014 Sony Corporation



Digital Music Player
NWZ-B183/B183F

Before Use

[Before first use](#)

Be sure to read this manual before you use your Walkman for the first time.



[Walkman instruction manuals](#)

There are a wide variety of instruction manuals available in addition to this Help Guide.



[Notes on use](#)

4-529-726-11(1)

Copyright 2014 Sony Corporation



Digital Music Player
NWZ-B183/B183F

Enjoying Using Your Walkman

[3 steps to listening to music](#)

This section explains how you can start enjoying using your Walkman after purchase in three simple steps: Charging the battery, transferring music and then playing back the music.



[Various ways to enjoy using your Walkman](#)

Your Walkman can do more than simply play back music. Get to know more about the many ways you can enjoy using the Walkman.



[Notes on use](#)

4-529-726-11(1)

Copyright 2014 Sony Corporation



Digital Music Player
NWZ-B183/B183F

Parts and Controls

[Parts and controls](#)

This section introduces the functions of buttons, jacks, and other parts of your Walkman.



[Notes on use](#)

4-529-726-11(1)

Copyright 2014 Sony Corporation



Digital Music Player
NWZ-B183/B183F

Power/Charging

[Turning the power on](#)

Turn the power on to start your Walkman.

[Turning the power off](#)

Turn the power off if you do not intend to use your Walkman for a long period of time.

[Using the HOLD switch](#)

You can use the HOLD switch to prevent the button from being pressed and operated accidentally.

[Charging the battery](#)

Connect your Walkman to a computer that is turned on and running to charge the battery.

[Extending the battery life](#)

This section introduces various ways to reduce battery consumption such as frequently turning the power off and changing various settings.

[Notes on charging the battery](#)

This section contains various notes about charging your Walkman.

[Notes on use](#)

4-529-726-11(1)

Copyright 2014 Sony Corporation



Digital Music Player
NWZ-B183/B183F

Initial Settings

[Selecting the display language](#)

This section explains how to set the language for menus and messages.



[Notes on use](#)

4-529-726-11(1)

Copyright 2014 Sony Corporation



Digital Music Player
NWZ-B183/B183F

Home Menu

[How to use the Home menu](#)

This section explains the basic operations of the Home menu, which is the starting point of each function.



[Notes on use](#)

4-529-726-11(1)

Copyright 2014 Sony Corporation



Digital Music Player
NWZ-B183/B183F

Connecting Your Walkman to Your Computer

[Connecting to a computer via USB](#)

Connect your Walkman to a computer via USB to charge the Walkman or exchange data.



[Notes on USB connection](#)

This section contains notes on the USB connection.



[Notes on use](#)

4-529-726-11(1)

Copyright 2014 Sony Corporation



Digital Music Player
NWZ-B183/B183F

Initializing/Updating

[Resetting your Walkman](#)

Reset your Walkman if operations become unstable.



[Resetting to the factory settings](#)

Reset your Walkman to the default settings.



[Formatting memory](#)

You can initialize your Walkman by formatting the memory.



[Updating the firmware of your Walkman](#)

Add new features to your Walkman by installing the latest firmware.



[Notes on use](#)

4-529-726-11(1)

Copyright 2014 Sony Corporation

Digital Music Player
NWZ-B183/B183F

Importing Content to the Software

[Importing music from media using Windows Media Player](#)

You can use Windows Media Player to import music from your CDs.



[Notes on use](#)

4-529-726-11(1)

Copyright 2014 Sony Corporation



Digital Music Player
NWZ-B183/B183F

Transferring Content to Your Walkman

[Transferring content using Windows Media Player](#)

You can use Windows Media Player to transfer content such as music from your computer to your Walkman.

[Transferring content using Explorer](#)

Use drag-and-drop in Windows Explorer to directly transfer content such as music to your Walkman.

[Notes for transferring content from your computer](#)

When transferring files and folders to your Walkman by drag-and-drop, you need to make sure that the default folder names remain unchanged and the hierarchy is correct.

[Notes on use](#)

4-529-726-11(1)

Copyright 2014 Sony Corporation



Digital Music Player
NWZ-B183/B183F

Deleting Content from Your Walkman

[Deleting content from your Walkman using Explorer](#)

You can use Windows Explorer to delete content such as music stored on your Walkman.



[Notes on use](#)

4-529-726-11(1)

Copyright 2014 Sony Corporation



Digital Music Player
NWZ-B183/B183F

Playing Music

[Preparing music](#)

You need to transfer music from your computer to your Walkman in order to listen to music on the Walkman.

[Playing music](#)

Play music that you imported from your computer to your Walkman.

[Volume operation \(Only for countries/areas complying with European and Korean Directives\)](#)

An alarm (beep) and a warning [Check the volume level] are meant to protect your ears when you turn the volume up to a level which is harmful for your ears for the first time. You can cancel the alarm and warning by pressing any button.

[Browsing the music playback screen](#)

See how to browse the information on the music playback screen.

[Music playback operations](#)

Use various operations from the music playback screen.

[Notes on use](#)

4-529-726-11(1)

Copyright 2014 Sony Corporation



Digital Music Player
NWZ-B183/B183F

Deleting Songs

[Deleting songs](#)

Use a computer to delete songs previously transferred to your Walkman.



[Notes on use](#)

4-529-726-11(1)

Copyright 2014 Sony Corporation

Digital Music Player
NWZ-B183/B183F

Music Settings

[Shuffle playback](#)

Play songs in the playback range in random order.

[Repeat playback](#)

Play songs within a range repeatedly.

[Bass Boost settings](#)

You can increase the level of the bass (low) sound range.

[Customizing sound quality settings](#)

You can use various functions to set the desired sound quality.

[Presetting your equalizer settings](#)

You can preset the values of the 5 band equalizer as a custom setting.

[Notes on use](#)

4-529-726-11(1)

Copyright 2014 Sony Corporation



Digital Music Player
NWZ-B183/B183F

Listening to FM Radio

[Listening to FM radio](#)

Listen to FM radio on your Walkman.

[Browsing the FM radio screen](#)

View how to browse the information on the FM radio screen.

[FM radio operations](#)

Select the desired frequency or preset number on the FM radio screen.

[Presetting broadcast stations automatically](#)

You can search for and automatically preset up to 30 receivable FM broadcast stations in your area.

[Presetting broadcast stations manually](#)

You can manually preset receivable FM broadcast stations.

[Deleting preset broadcast stations](#)

You can delete preset FM broadcast stations.

[Notes on use](#)

4-529-726-11(1)

Copyright 2014 Sony Corporation

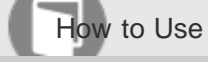

Digital Music Player
NWZ-B183/B183F

FM Radio Settings

[Changing the FM radio scan sensitivity](#)

You can change the scan sensitivity if the FM radio reception sensitivity is too strong, causing many unwanted broadcast stations to be received.



[Presetting broadcast stations automatically](#)

You can search for and automatically preset up to 30 receivable FM broadcast stations in your area.



[Notes on use](#)

4-529-726-11(1)

Copyright 2014 Sony Corporation



Digital Music Player
NWZ-B183/B183F

FM Radio Recording

[Making FM radio recordings](#)

You can record FM radio programs on your Walkman.

[Playing FM radio recordings](#)

You can play recorded FM radio programs on your Walkman.

[Deleting FM radio recordings](#)

You can delete recorded FM radio programs from your Walkman.

[Notes on use](#)

4-529-726-11(1)

Copyright 2014 Sony Corporation

Digital Music Player
NWZ-B183/B183F

Music Settings

[Shuffle playback](#)

Play songs in the playback range in random order.

[Repeat playback](#)

Play songs within a range repeatedly.

[Bass Boost settings](#)

You can increase the level of the bass (low) sound range.

[Customizing sound quality settings](#)

You can use various functions to set the desired sound quality.

[Presetting your equalizer settings](#)

You can preset the values of the 5 band equalizer as a custom setting.

[Notes on use](#)

4-529-726-11(1)

Copyright 2014 Sony Corporation

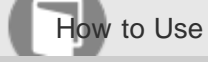

Digital Music Player
NWZ-B183/B183F

FM Radio Settings

[Changing the FM radio scan sensitivity](#)

You can change the scan sensitivity if the FM radio reception sensitivity is too strong, causing many unwanted broadcast stations to be received.



[Presetting broadcast stations automatically](#)

You can search for and automatically preset up to 30 receivable FM broadcast stations in your area.



[Notes on use](#)

4-529-726-11(1)

Copyright 2014 Sony Corporation



Digital Music Player
NWZ-B183/B183F

Common Settings

[Limiting the volume](#)

You can use AVLS (Automatic Volume Limiter System) to limit the maximum volume.



[Setting the operation sound](#)

You can change the operating sounds of your Walkman.



[Setting the screen off timer](#)

You can set the time after which the screen is turned off when there are no operations. You can preserve battery power by setting this to a shorter time.



[Adjusting the screen brightness](#)

You can set the screen brightness to one of 5 levels. You can preserve battery power by setting this to a lower level.



[Notes on use](#)

4-529-726-11(1)

Copyright 2014 Sony Corporation

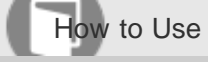

Digital Music Player
NWZ-B183/B183F

Unit Information

[Displaying your Walkman information](#)

View information on your Walkman, such as the model name and software version.



[Notes on use](#)

4-529-726-11(1)

Copyright 2014 Sony Corporation



Digital Music Player
NWZ-B183/B183F

Language Settings

[Selecting the display language](#)

This section explains how to set the language for menus and messages.



[Notes on use](#)

4-529-726-11(1)

Copyright 2014 Sony Corporation

Digital Music Player
NWZ-B183/B183F

Reset/Format

[Resetting to the factory settings](#)

Reset your Walkman to the default settings.



[Formatting memory](#)

You can initialize your Walkman by formatting the memory.



[Notes on use](#)

4-529-726-11(1)

Copyright 2014 Sony Corporation



Digital Music Player
NWZ-B183/B183F

Precautions

Warning

Important warnings for using your Walkman are explained. Be sure to follow these instructions.

Caution

Important information for using your Walkman is explained.

Notice for users

Important notices for users are explained.

Notes on headphones

Important notes for the headphones are explained.

Notes on the software

Important notes for the software are explained.

Notes on use

4-529-726-11(1)

Copyright 2014 Sony Corporation

Digital Music Player
NWZ-B183/B183F

Customer Support Website

[Customer support website](#)

Visit the customer support website if you have any questions or issues with your Walkman, or if you would like information on compatible accessories, etc. 

[Notes on use](#)

4-529-726-11(1)

Copyright 2014 Sony Corporation



Digital Music Player
NWZ-B183/B183F

Specifications

[Specifications](#)

Details on the Walkman specifications (size, weight, and memory size, etc.) are shown. 

[Battery life](#)

The estimated battery usage hours based on typical usage conditions and settings are explained. 

[Maximum recordable number of songs and time \(Approx.\)](#)

The maximum recordable number of songs and time are explained. 

[Maximum recordable time \(Approx.\)](#)

The maximum recordable time are explained. 

[Supported formats](#)

The file formats that are supported by your Walkman are explained. 

[System requirements](#)

Details on the system requirements needed to use your Walkman (the operating system version and memory size, etc.) are shown. 

[Contents](#)

A list of accessories and manuals supplied with your Walkman is shown. 

[Notes on use](#)

4-529-726-11(1)

Copyright 2014 Sony Corporation

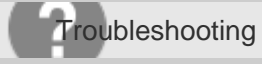

Digital Music Player
NWZ-B183/B183F

What Can I Do to Solve a Problem?

[What can I do to solve a problem?](#)

This section contains solutions for when your Walkman does not function as expected or if a problem occurs during operation. 

[Customer support website](#)

Visit the customer support website if you have any questions or issues with your Walkman, or if you would like information on compatible accessories, etc. 

[Notes on use](#)

4-529-726-11(1)

Copyright 2014 Sony Corporation

Digital Music Player
NWZ-B183/B183F

Operation

[Your Walkman does not operate or the power does not turn on.](#) 

[Your Walkman does not work properly.](#) 

[Your Walkman power turns off or on automatically.](#) 

[I want my Walkman screen to stay on longer before it turns off automatically.](#) 

[A drink \(water, coffee, etc.\) was spilled on your Walkman, or the Walkman was washed in the washing machine.](#) 

[I want to backup the content such as music saved on my Walkman.](#) 

[I want to find the product name \(model name\) of my Walkman.](#) 

[An alarm \(beep\) is heard and the message \[Check the volume level\] is displayed.](#) 

Notes on use

4-529-726-11(1)

Copyright 2014 Sony Corporation



Digital Music Player
NWZ-B183/B183F

Sound

[There is no sound.](#)



[The content such as music suddenly stops during playback.](#)



[Noise is generated.](#)



[Volume cannot be turned up, or the volume remains low when the playback volume is turned up.](#)



[Sound can only be heard from one side of the headphones.](#)



[Sound is interrupted or skips.](#)



[Notes on use](#)

4-529-726-11(1)

Copyright 2014 Sony Corporation



Digital Music Player
NWZ-B183/B183F

Power

[Cannot charge the Walkman.](#)



[What is the battery life of the built-in rechargeable battery?](#)



[The rechargeable battery needs to be replaced.](#)



[The battery duration is short.](#)



[What is the standard battery duration?](#)



[How long does it take to charge the battery?](#)



[Notes on use](#)

4-529-726-11(1)

Copyright 2014 Sony Corporation

Digital Music Player
NWZ-B183/B183F

Connection to a Computer

The computer does not recognize your Walkman. 

Even if you use “Safely Remove Hardware” on the computer, [Connecting USB] remains displayed on your Walkman screen. 

Content such as music cannot be transferred from the computer to your Walkman. 

Only a small amount of content such as music can be transferred to your Walkman. 

Your Walkman becomes unstable when it is connected to the computer. 

Notes on use

4-529-726-11(1)

Copyright 2014 Sony Corporation



Digital Music Player
NWZ-B183/B183F

Displaying/Playing/Deleting Content

[Cannot play content such as music transferred to your Walkman.](#)



[Songs are not played back in the expected order.](#)



[\[□ \] is displayed in the screen.](#)



[\[Unknown\] is displayed for the album name or artist name.](#)



[Cannot delete content such as music using the Walkman functions.](#)



[Notes on use](#)

4-529-726-11(1)

Copyright 2014 Sony Corporation

Digital Music Player
NWZ-B183/B183F

Recordings

The remaining recording time remains the same even though files are deleted.



Cannot record.



The combined total elapsed and remaining recording time does not equal the maximum recording time.



A folder is not deleted even though all recorded files have been deleted.



Notes on use

4-529-726-11(1)

Copyright 2014 Sony Corporation

Digital Music Player
NWZ-B183/B183F

FM Radio

[Cannot hear FM radio broadcasts.](#)



[There is a lot of noise in the FM radio broadcast and the sound quality is poor.](#)



[Notes on use](#)

4-529-726-11(1)

Copyright 2014 Sony Corporation



Digital Music Player
NWZ-B183/B183F

Other

[Your Walkman gets warm.](#)



[Notes on use](#)

4-529-726-11(1)

Copyright 2014 Sony Corporation



Digital Music Player
NWZ-B183/B183F

Customer registration website

We recommend that you register your Walkman so we can provide better customer support. Visit one of the following websites to register the Walkman.

For customers in the USA:

<http://www.sony.com/walkmanreg/>

For customers in Canada:

English

<http://www.Sony.ca/Registration>

French

<http://www.Sony.ca/Enregistrement>

For customers in Latin America:

<http://www.sony-latin.com/registration>

For customers in Europe:

<http://walkman.sony-europe.com/usb-registration>

For customers in Asia/Oceania/Middle East/Africa:

English/Korean/Traditional Chinese

<http://www.sony-asia.com/dmpwalkman/register/>

Simplified Chinese

https://www.sonystyle.com.cn/b2c_sony/b2c/productRegister.do

Notes on use

4-529-726-11(1)

Copyright 2014 Sony Corporation



Digital Music Player
NWZ-B183/B183F

Before first use

Thank you for purchasing this Walkman.

This “Help Guide” explains how to transfer content to your Walkman, and how to use the various functions. Browse this “Help Guide” for necessary information.

The printed manuals supplied with your Walkman, such as “Quick Start Guide,” also contain important information for you. For information about the customer support website, see “Customer support website.”

For more information on laws, regulations and trademark rights, refer to “Important Information” contained in the supplied software. To read it, install the supplied software on your computer.

All other trademarks and registered trademarks are trademarks or registered trademarks of their respective holders. In this manual, TM and ® marks are not specified.

About model names mentioned in this “Help Guide”

Depending on the country/region in which you have purchased your Walkman, some models may not be available.

Computer system requirements when connecting the Walkman

See the “System requirements” for details on computer system requirements.

Battery charging

The battery might be low when you use your Walkman for the first time. Charge the battery before using the Walkman.

About images used in this “Help Guide”

The screens and illustrations shown are images only, and may differ from the actual product or screen.

Related Topic

- [System requirements](#)
- [Customer support website](#)
- [Charging the battery](#)



Digital Music Player
NWZ-B183/B183F

Walkman instruction manuals

The operations of this Walkman are explained in the following instruction manuals.

Quick Start Guide (paper)

Describes the basic operating instructions and how to install the supplied software (provided only in some languages).

Help Guide

You are currently viewing the Help Guide. This contains information such as explanations of Walkman operations and software.

Important Information

Contains information on trademark rights, laws, and regulations. You can read it by installing the supplied software on your computer.

[Notes on use](#)

4-529-726-11(1)

Copyright 2014 Sony Corporation

Digital Music Player
NWZ-B183/B183F

3 steps to listening to music

Be sure to charge the battery before you use your Walkman for the first time. You can transfer music while charging the battery. You can listen to your music as soon as the transfer has completed.

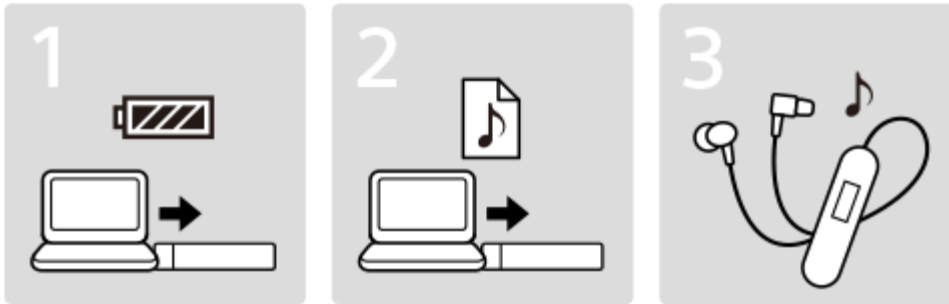
**1. Connect your Walkman to a computer.**

You can charge the battery by connecting your Walkman via a USB connection to a computer that is turned on and running.

2. Import music to your computer and transfer the music to your Walkman.

For Windows users

- You can transfer music by drag-and-drop directly from Windows Explorer to your Walkman.

3. Enjoy your music!

Connect the headphones, unlock the HOLD function and turn on your Walkman. Then simply select the music you want to listen to to start playback!

Related Topic

- [Charging the battery](#)
- [Playing music](#)
- [Transferring content using Windows Media Player](#)
- [Turning the power on](#)



Digital Music Player
NWZ-B183/B183F

Various ways to enjoy using your Walkman

Your Walkman can do more than simply play back music. Get to know more about the many ways you can enjoy using the Walkman.

Listening to FM radio

You can enjoy listening to FM radio on your Walkman. (NWZ-B183F only)

Related Topic

[Listening to FM radio](#)

[Notes on use](#)

4-529-726-11(1)

Copyright 2014 Sony Corporation

Digital Music Player
 NWZ-B183/B183F

Parts and controls

This section explains the functions of buttons, jacks, and other parts of your Walkman.

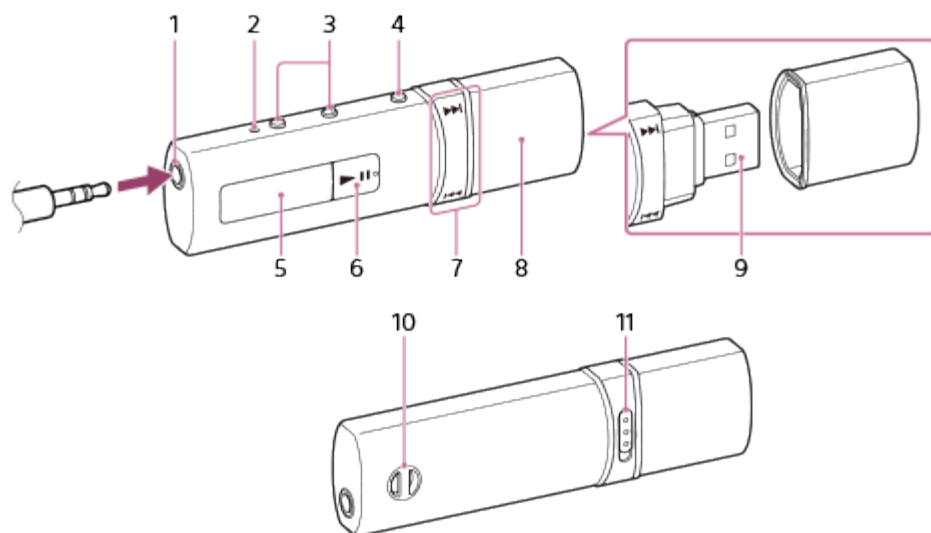

1. Headphone jack

Insert the headphone plug until it clicks into place. Sound will be impaired if the headphones are not connected properly.

2. RESET button

Press the RESET button with a pen or paper clip, etc. to reset your Walkman. While the Walkman is connected to the computer via USB, you cannot reset the Walkman.

3. VOL + (*1)/- buttons

Press to adjust the volume.

4. BACK/HOME button

Press to go up one list screen level or to return to the previous menu. Press and hold to display the Home menu.

5. Display

6. ▶|| (*1) button

Executes the desired items. Starts/pauses music playback, or pauses/restarts recording.

7. ◀◀ / ▶▶ button

Press to select a menu item, start fast-rewinds/forwards during playback, or preset an FM station.

8. USB cap

Before you connect your Walkman to your computer, remove the USB cap.

9. USB connector

10. Strap holes

Use to attach a strap (not supplied).

11. HOLD switch

Disables the operation buttons to avoid accidental operation while carrying your Walkman.

(*1) There is a tactile dot to help with button operations.

Related Topic

- [Turning the power on](#)
- [Turning the power off](#)
- [How to use the Home menu](#)
- [Resetting your Walkman](#)

Notes on use

4-529-726-11(1)

Copyright 2014 Sony Corporation

Digital Music Player
NWZ-B183/B183F

Turning the power on

Turn on the power to start your Walkman.

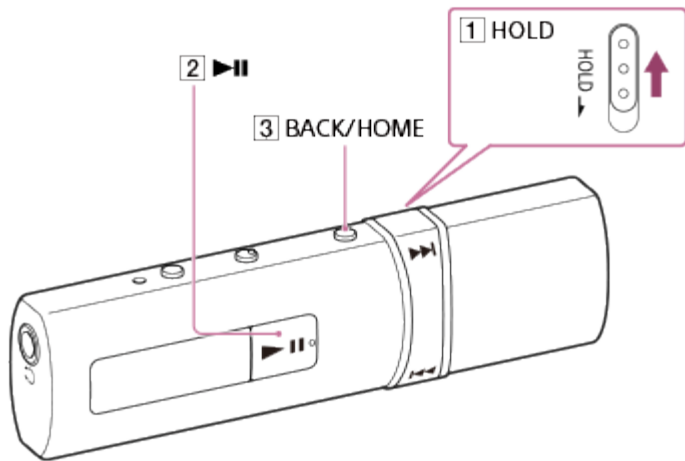

1. Slide the **1** switch to unlock your Walkman.
2. Press the **2** button.

Hint

- If your Walkman is not operated, the screen will be turned off. To turn on the screen, press the **3** button.
- If there is no operation for an extended period, your Walkman will be turned off automatically.

Related Topic

- [Parts and controls](#)
- [Using the HOLD switch](#)
- [Setting the screen off timer](#)
- [Turning the power off](#)

Digital Music Player
NWZ-B183/B183F

Turning the power off

Turn off the power when not using your Walkman for an extended period of time.

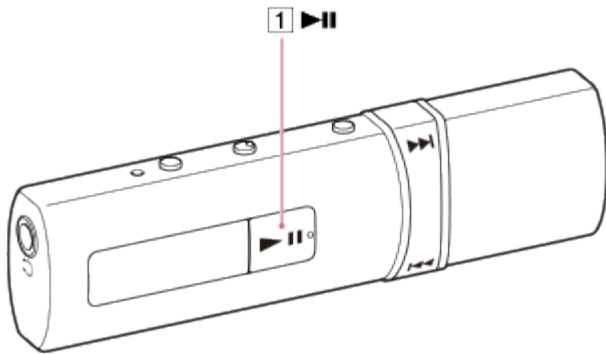

1. Press and hold the  button.
[POWER OFF] appears.

Hint

- If there is no operation for an extended period, your Walkman will be turned off automatically.

Related Topic

- [Parts and controls](#)
- [Setting the screen off timer](#)
- [Turning the power on](#)

Notes on use

4-529-726-11(1)

Copyright 2014 Sony Corporation

Digital Music Player
NWZ-B183/B183F

Using the HOLD switch

You can use the HOLD switch to prevent the button from being pressed and operated accidentally.

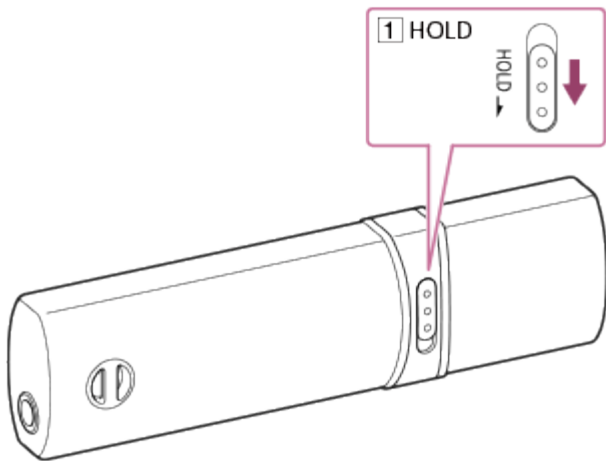

1. Slide the **1** switch in the direction of the arrow.
The HOLD function is enabled and all operation buttons are disabled.

Hint

- Slide the **1** switch to the opposite position to release the HOLD function.
-  [HOLD] is displayed if buttons are pressed while the HOLD function is enabled.

Related Topic

- [Parts and controls](#)

[Notes on use](#)

4-529-726-11(1)

Copyright 2014 Sony Corporation

Digital Music Player
NWZ-B183/B183F

Charging the battery

Charge your Walkman by connecting it to a computer.



1. Remove the USB cap.
2. Connect your Walkman to a running computer via USB.
The battery status icon shows  when charging is complete.
It takes about 70 minutes to fully charge the battery.
3. Disconnect your Walkman from the computer when charging is complete.

Hint

- You can check the remaining battery charge in the music playback and the FM radio screens.
- When you charge your Walkman when it has not been used for a long period of time or when you use it for the first time, your computer may not recognize it, or nothing may appear on the screen. The Walkman should start operating normally again after charging for about 10 minutes.

Note

- You cannot operate your Walkman when it is connected to a computer.
- You cannot operate your Walkman while charging the battery.

Related Topic

- [Connecting to a computer via USB](#)

- [Extending the battery life](#)
- [Browsing the music playback screen](#)
- [Browsing the FM radio screen](#)
- [Notes on charging the battery](#)

[Notes on use](#)

4-529-726-11(1)

Copyright 2014 Sony Corporation



Digital Music Player
NWZ-B183/B183F

Extending the battery life

You can reduce battery consumption by using your Walkman as follows.

For a comparison of battery life based on set effects, default settings and functions, see “Battery life.”

- Turn off the power manually.
- Set a shorter time in [Screen Off Timer].
- Adjust screen brightness.
- Turn off the operation sounds.
- Set all sound quality settings to off.

Related Topic

- [Turning the power on](#)
- [Turning the power off](#)
- [Setting the screen off timer](#)
- [Customizing sound quality settings](#)
- [Battery life](#)

[Notes on use](#)

4-529-726-11(1)

Copyright 2014 Sony Corporation



Digital Music Player
NWZ-B183/B183F

Notes on charging the battery

- Charging time differs depending on battery usage conditions.
- If the battery life is reduced to about half of its normal life even if sufficiently charged, it has probably worn out. Please contact your nearest Sony dealer.
- If you charge your Walkman when it has not been used for a long period of time, your computer may not recognize it, or the Walkman may not respond. Charge the Walkman for about 10 minutes, after which it should start operating normally again.
- When  is displayed on the screen, the ambient temperature exceeds the recommended range and charging is forcibly stopped. Charge the battery in an ambient temperature of between 5 °C to 35 °C.
- The number of times the battery can be recharged from complete discharge is approximately 500 times. This number may vary depending on the conditions under which you use your Walkman.
- Charge the battery at least once every six months to a year even if you do not use your Walkman for a long period of time.
- Charging is not guaranteed with homebuilt or modified computers.
- Operation with a USB port extended with a USB hub is only guaranteed when a self-powered USB hub that carries an authorized logo is used.
- Do not leave your Walkman connected for an extended period of time to a laptop computer that is not connected to an AC power supply. Doing so may discharge the computer's battery.
- Do not turn on, restart, wake up from sleep mode, or shut down the computer with your Walkman connected to the computer via USB. Doing so may cause the Walkman to malfunction. Disconnect the Walkman from the computer before conducting these operations.
- Your Walkman may become hot while charging. This is not a malfunction.
- You cannot operate your Walkman when it is connected to a computer.
- You cannot operate your Walkman while charging the battery.
- The battery indicator scales are not equal. Refer the battery indicator as a guide.
- [Do not disconnect] is displayed when transferring data between your Walkman and the computer. Do not disconnect the Walkman from your computer when [Do not disconnect] is displayed. Doing so may result in loss of the data being transferred and data on the Walkman.

[Notes on use](#)

4-529-726-11(1)

Copyright 2014 Sony Corporation

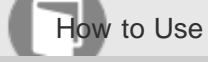

Digital Music Player
NWZ-B183/B183F

Selecting the display language

You can select from a variety of languages for menus and messages.

1. From the Home menu, select  [Settings].
2. Select [Language Settings] - desired language setting.

Related Topic

[How to use the Home menu](#)

Notes on use

4-529-726-11(1)

Copyright 2014 Sony Corporation

Digital Music Player
NWZ-B183/B183F

How to use the Home menu

Each menu can be accessed from the Home menu. Start here when searching for songs, changing settings, etc.



1. You can select the music you want to listen to to start playback.
2. You can enjoy FM radio programs. (*1)
3. You can change various settings on your Walkman.

(*1) NWZ-B183F only

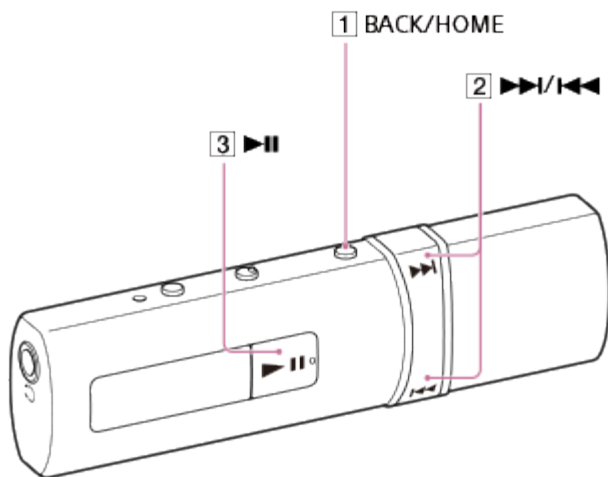

1. Press and hold the **1** button until  [Music] in the Home menu is displayed.
2. Press the **2** button to select the desired menu and then press the **3** button to confirm.

Hint

- To return to the previous screen during operation, press the **[1]** button.
- To return to  [Music] in the Home menu during operation, press and hold the **[1]** button.

Related Topic

- [Playing music](#)
- [Listening to FM radio](#)

Notes on use

4-529-726-11(1)

Copyright 2014 Sony Corporation

Digital Music Player
NWZ-B183/B183F

Connecting to a computer via USB

Connect your Walkman to a computer via USB to charge the Walkman or exchange data.



1. Remove the USB cap.
2. Connect your Walkman to a running computer via USB.

Note

- You cannot operate your Walkman when it is connected to a computer.

Hint

- If you are prompted to make a Windows operation, click “Cancel” or “x.”

Related Topic

- [Notes on USB connection](#)
- [Transferring content using Windows Media Player](#)
- [Charging the battery](#)
- [Transferring content using Explorer](#)



Digital Music Player
NWZ-B183/B183F

Notes on USB connection

- Your Walkman cannot be operated when connected to a computer.
- Do not disconnect your Walkman from your computer when transferring data between the Walkman and the computer via USB. Doing so may result in loss of the data being transferred and data on the Walkman.
- Do not turn on, restart, wake up from sleep mode, or shut down the computer with your Walkman connected to the computer via USB. Doing so may cause the Walkman to malfunction. Disconnect the Walkman from the computer before conducting those operations.

[Notes on use](#)

4-529-726-11(1)

Copyright 2014 Sony Corporation

Digital Music Player
NWZ-B183/B183F

Resetting your Walkman

Try resetting your Walkman if operations become unstable.

Before resetting your Walkman, disconnect the Walkman from your computer and check that no content such as music is being played, otherwise the data may be damaged.

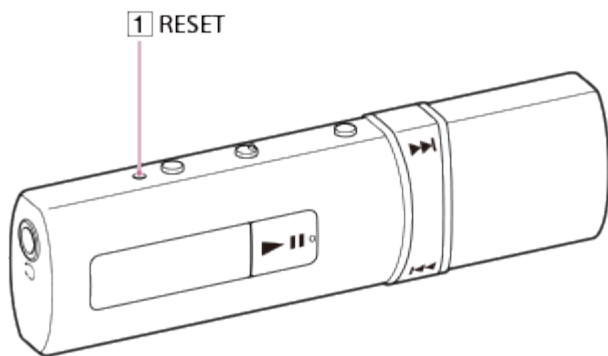

1. Press the  button with a pen or a paper clip, etc. to reset your Walkman.

Note

- Resetting your Walkman will not delete any data or reset any settings.

Related Topic

- [Resetting to the factory settings](#)
- [Formatting memory](#)
- [Customer support website](#)

[Notes on use](#)

4-529-726-11(1)

Copyright 2014 Sony Corporation



Digital Music Player
NWZ-B183/B183F

Resetting to the factory settings

Your Walkman can be reset to the default settings.
Resetting the Walkman will not delete content such as music.

1. From the Home menu, select  [Settings].
2. Select [Reset/Format] - [Reset All Settings] - [Yes].

Related Topic

- [Resetting your Walkman](#)
- [Formatting memory](#)

Notes on use

4-529-726-11(1)

Copyright 2014 Sony Corporation

Digital Music Player
NWZ-B183/B183F

Formatting memory

You can initialize your Walkman by formatting the memory.

1. From the Home menu, select  [Settings].
2. Select [Reset/Format] - [Format].
3. Follow the on-screen instructions to format the memory.

Note

- Be sure not to initialize (format) the memory of your Walkman using a computer. If you have formatted it with a computer, format it again using the Walkman.
- Formatting the memory erases all content data (songs, etc., including the sample data installed at the factory, the supplied software installer, and the “Help Guide.”) Be sure to check the data stored in the memory and export any important data to the hard disk of your computer before formatting.

Related Topic

- [Resetting your Walkman](#)
- [Resetting to the factory settings](#)

Notes on use

4-529-726-11(1)

Copyright 2014 Sony Corporation

Digital Music Player
NWZ-B183/B183F

Updating the firmware of your Walkman

You can add new features to your Walkman by installing the latest firmware. For details on the latest firmware information and how to install it, visit the customer support website for your area.

1. Download the update program to your computer from the website.
2. Connect your Walkman to your computer and start the update program.
3. Follow the on-screen instructions to update the firmware of your Walkman.

Hint

- To confirm the version information of your Walkman, select  [Settings] - [Unit Information] from the Home menu.

Related Topic

- [Customer support website](#)
- [Displaying your Walkman information](#)
- [Connecting to a computer via USB](#)

Notes on use

4-529-726-11(1)

Copyright 2014 Sony Corporation

Digital Music Player
NWZ-B183/B183F

Importing music from media using Windows Media Player

You can use Windows Media Player to import music from your CDs. Follow these instructions to import music from a CD to your computer.



1. Insert an audio CD.
2. Start up Windows Media Player, and then click the “Rip” tab at the top of the window.
When the computer is connected to the Internet, Windows Media Player obtains CD information (CD title, song name or artist name, etc.), and displays it in the window.
3. Click “Start Rip.”
Windows Media Player begins to import the CD. The imported music is indicated as “Ripped to library.” Wait until all songs have been imported.

Hint

- For details on how to import music from CDs, refer to the Help of Windows Media Player.
- For details about usage or support on Windows Media Player, refer to Windows Media Player information from the following website:
<http://support.microsoft.com/>
- Imported music is stored in the “My Music” folder (Windows 7/Windows 8/Windows 8.1) or “Music” folder (Windows Vista) of the computer. Click the “Library” tab of the Windows Media Player window to find them.

Note

- Imported music is for private use only. Use of a song beyond this limitation requires the permission of the copyright holders.

Notes on use

4-529-726-11(1)

Copyright 2014 Sony Corporation



Digital Music Player
NWZ-B183/B183F

Transferring content using Windows Media Player

You can use Windows Media Player to transfer content such as music from your computer to your Walkman.

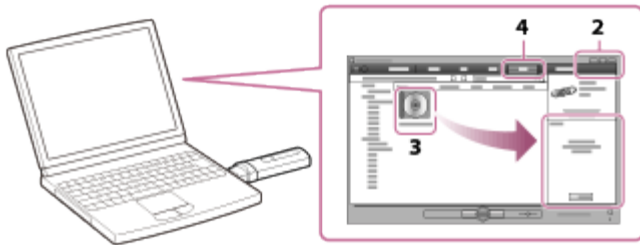

1. Start up Windows Media Player, and then connect your Walkman to your computer via USB.
2. Click the “Sync” tab on the Windows Media Player window.
3. Drag-and-drop the desired songs to the Sync List on the right side of the window.
The songs are added to the Sync List.
4. Click “Start Sync” to start synchronization.
When synchronization is completed, a message confirming you can disconnect your Walkman appears on the Sync List. After completion, close Windows Media Player, and disconnect the Walkman from the computer.

Hint

- You can also transfer content directly from Windows Explorer to your Walkman by drag-and-drop.
- For details on how to import music from CDs, refer to the Help of Windows Media Player.
- For details about usage or support on Windows Media Player, refer to Windows Media Player information from the following website:

<http://support.microsoft.com/>

Note

- You cannot operate your Walkman when it is connected to a computer.
- Content with copyright protection cannot be transferred.
- Playlist data cannot be transferred to your Walkman.

Related Topic

- [Transferring content using Explorer](#)

Notes on use

4-529-726-11(1)

Copyright 2014 Sony Corporation

Digital Music Player
NWZ-B183/B183F

Transferring content using Explorer

Content such as music can be directly transferred by drag-and-drop using Windows Explorer.

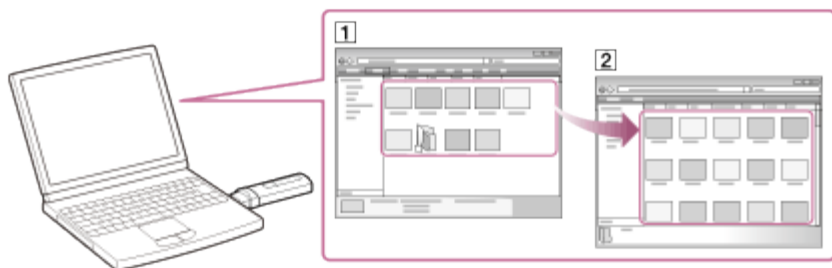

1. Connect your Walkman to a running computer via USB.
2. Open the "WALKMAN" folder using the procedure below that corresponds to your computer.
 - Windows 7 or earlier:
From the "Start" menu of Windows, click "Computer" or "My Computer" and open the "WALKMAN" folder.
 - Windows 8 or Windows 8.1:
Select "Desktop" from the "Start screen" to open "File Explorer." From the "Computer" list, open the "WALKMAN" folder.
3. Open the folder to which you want to transfer files.
To transfer music files or folders: "MUSIC" folder
4. Drag-and-drop the desired files or folders ([1]) to the applicable folder ([2]) in the "WALKMAN" folder.

Note

- You cannot operate your Walkman when it is connected to a computer.
- Only MP3/WMA files can be played on your Walkman.
- Do not change folder name or delete the "MUSIC" folder.
- Some songs may not be played back on your Walkman due to copyright protection.
- Do not disconnect your Walkman while the data is transferred. Otherwise, data being transferred or stored on the Walkman may be damaged. If the Walkman is disconnected while files are being transferred, unnecessary files may be left in the Walkman. In this case, transfer usable files back to the computer and format the Walkman.

- [Connecting to a computer via USB](#)
- [Notes for transferring content from your computer](#)

Notes on use

4-529-726-11(1)

Copyright 2014 Sony Corporation

Digital Music Player
NWZ-B183/B183F

Notes for transferring content from your computer

Drag-and-drop content such as music or folders into the correct folder as shown in the following illustrations. Your Walkman can play back content stored in the 1st to 8th level of each folder.

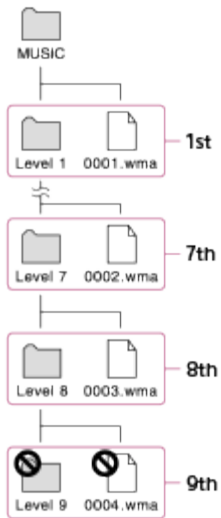
**Note**

- Do not rename the following default folders.
 - _MUSIC
 - _RECORD
 - └ FM

Otherwise, they will not be displayed on your Walkman anymore.

- Copyright protected files that were transferred to your Walkman using drag-and-drop cannot be played back on the Walkman.

[Notes on use](#)



Digital Music Player
NWZ-B183/B183F

Deleting content from your Walkman using Explorer

Delete content such as music stored on your Walkman using Windows Explorer.

1. Connect your Walkman to a running computer via USB.
2. Open the "WALKMAN" folder using the procedure below that corresponds to your computer.
 - Windows 7 or earlier:
From the "Start" menu of Windows, click "Computer" or "My Computer" and open the "WALKMAN" folder.
 - Windows 8 or Windows 8.1:
Select "Desktop" from the "Start screen" to open "File Explorer." From the "Computer" list, open the "WALKMAN" folder.
3. Open the "MUSIC" folder.
4. Select the content that you want to delete.
5. Delete the content.

Related Topic

- [Connecting to a computer via USB](#)
- [Transferring content using Windows Media Player](#)
- [Transferring content using Explorer](#)

Notes on use

4-529-726-11(1)

Copyright 2014 Sony Corporation



Digital Music Player
NWZ-B183/B183F

Preparing music

You need to transfer music from your computer to your Walkman in order to listen to music on the Walkman. After importing songs from a CD to your computer, transfer them by drag-and-drop from Windows Explorer to the Walkman.

Related Topic

- [Connecting to a computer via USB](#)
- [Transferring content using Windows Media Player](#)

[Notes on use](#)

4-529-726-11(1)

Copyright 2014 Sony Corporation

Digital Music Player
NWZ-B183/B183F

Playing music

Play music imported to your Walkman.

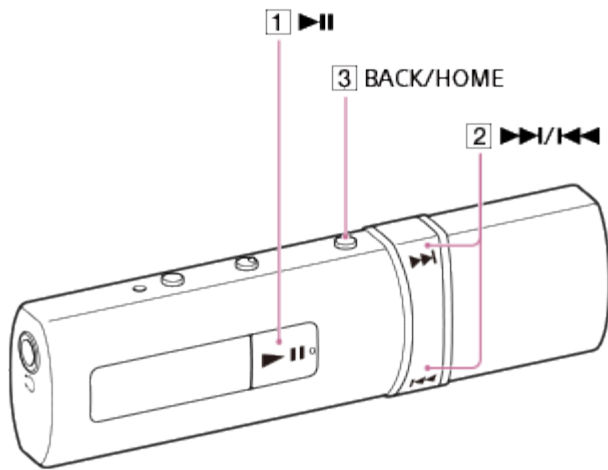

1. From the Home menu, select  [Music].
2. Press the **2** button to select the desired search method. Select the desired items until a song list appears, then select the desired song.
3. Press the **1** button to play the song.
Playback starts and the music playback screen is displayed. To pause playback, press the **1** button.

Note

- If your Walkman is not operated, the screen will be turned off. To turn on the screen, press the **3** button.
- If there is no operation for an extended period while paused, your Walkman will be turned off automatically.

Related Topic

- [Preparing music](#)
- [Music playback operations](#)
- [Setting the screen off timer](#)
- [Browsing the music playback screen](#)



Digital Music Player
NWZ-B183/B183F

Volume operation (Only for countries/areas complying with European and Korean Directives)

An alarm (beep) and a warning [Check the volume level] are meant to protect your ears when you turn the volume up to a level which is harmful for your ears for the first time. You can cancel the alarm and warning by pressing any button.

Note

- You can turn up the volume after canceling the alarm and warning.
- After the initial warning, the alarm and warning repeat for every 20 cumulative hours that the volume is set to a level which is harmful for your ears; when this happens, the volume is turned down automatically.
- If the volume is set to a level which is harmful for your ears and you turn off the Walkman, the volume is turned down to a level which is safe for your ears automatically.

[Notes on use](#)

4-529-726-11(1)

Copyright 2014 Sony Corporation

Digital Music Player
NWZ-B183/B183F

Browsing the music playback screen

The following items are displayed on the music playback screen.

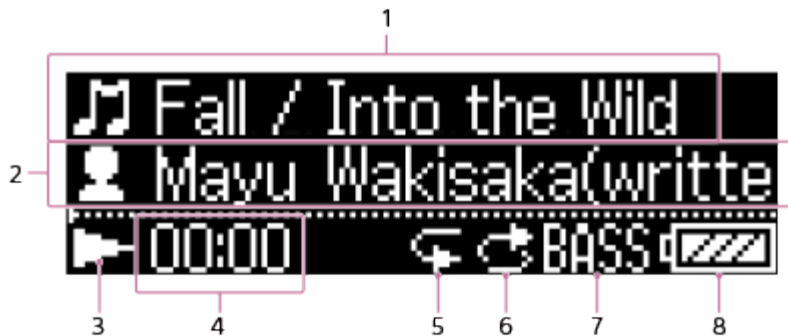

1. Song title
2. Selected search method
3. Playback status
Play (▶), pause (⏸), fast forward (⏩), fast rewind (⏪), go to beginning of previous (or current) song (⏮), or go to beginning of next song (⏭) indication icons.
4. Elapsed time of current song
5. Repeat indication
6. Shuffle indication
7. Equalizer/Bass Boost indication
8. Battery status icon

Note

- The items shown on the screen may differ depending on the playback status, the settings, and the current screen.

Related Topic

- [Playing music](#)
- [Shuffle playback](#)
- [Repeat playback](#)
- [Customizing sound quality settings](#)
- [Music playback operations](#)

Notes on use

4-529-726-11(1)

Copyright 2014 Sony Corporation

Digital Music Player
NWZ-B183/B183F

Music playback operations

The following operations are available on the music playback screen.

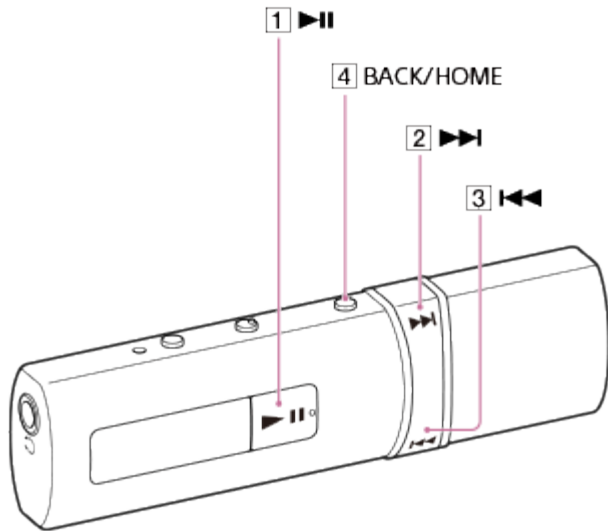

To play/pause
Press the **1** button.

To fast forward or rewind
Press and hold the **2** or **3** button.

To go to the beginning of the next song or go to the beginning of the previous (or current) song
Press the **2** or **3** button.

Hint

- You can set shuffle/repeat playback and sound quality functions such as the equalizer from  [Settings] - [Music Settings].
- If your Walkman is not operated, the screen will be turned off. To turn on the screen, press the **4** button.
- If there is no operation for an extended period while paused, your Walkman will be turned off automatically.

- [Playing music](#)
- [Browsing the music playback screen](#)
- [Shuffle playback](#)
- [Repeat playback](#)
- [Setting the screen off timer](#)
- [Customizing sound quality settings](#)
- [Bass Boost settings](#)

Notes on use

4-529-726-11(1)

Copyright 2014 Sony Corporation



Digital Music Player
NWZ-B183/B183F

Deleting songs

To delete songs from your Walkman, use the software on your computer that you used to transfer the songs. If you used Windows Explorer to transfer the songs, use Windows Explorer to delete them.

Note

- Do not delete or rename the “MUSIC” folder. Otherwise, songs may not be displayed or played on your Walkman.

Related Topic

• [Deleting content from your Walkman using Explorer](#)

Notes on use

4-529-726-11(1)

Copyright 2014 Sony Corporation



Digital Music Player
NWZ-B183/B183F

Shuffle playback

Play songs in the playback range in random order.

1. From the Home menu, select [Settings].
2. Select [Music Settings] - [Shuffle] - [Shuffle On].
 is displayed on the music playback screen.

Hint

- To return to the music playback screen, press and hold the BACK/HOME button and select [Music] - [Go to playback screen].
- To play all songs on your Walkman in random order, play the songs from [Music] - [All Songs].

Related Topic

- [Playing music](#)
- [Browsing the music playback screen](#)
- [Music playback operations](#)
- [Repeat playback](#)

Notes on use



4-529-726-11(1)

Copyright 2014 Sony Corporation



Digital Music Player
NWZ-B183/B183F

Repeat playback

Play songs within a range repeatedly.

1. From the Home menu, select  [Settings].
2. Select [Music Settings] - [Repeat] - desired setting.
 (Repeat) or  (Repeat 1 Song) is displayed on the music playback screen.

Hint

- To return to the music playback screen, press and hold the BACK/HOME button and select  [Music] - [Go to playback screen].
- To play all songs on your Walkman repeatedly, play the songs from  [Music] - [All Songs].

Related Topic

- [Playing music](#)
- [Browsing the music playback screen](#)
- [Shuffle playback](#)
- [Music playback operations](#)

[Notes on use](#)

4-529-726-11(1)

Copyright 2014 Sony Corporation

Digital Music Player
NWZ-B183/B183F

Bass Boost settings

You can increase the level of the bass (low) sound range.

1. From the Home menu, select  [Settings].
2. Select [Music Settings] - [Bass Boost] - desired setting.

Hint

- The effects of the [Bass Boost] function are limited to protect your hearing when listening at high volume.

Note

- The [Equalizer] settings are not applied if [Bass Boost] is turned on.

Related Topic

- [Browsing the music playback screen](#)
- [Customizing sound quality settings](#)

Notes on use

4-529-726-11(1)

Copyright 2014 Sony Corporation



Digital Music Player
NWZ-B183/B183F

Customizing sound quality settings

You can use various functions to set the desired sound quality.

1. From the Home menu, select  [Settings].
2. Select [Music Settings] - [Equalizer] - desired setting.

Equalizer function

You can set the sound quality according to the music genre. You can also preset your equalizer settings as a custom setting.

Note

- The [Equalizer] setting is not applied if [Bass Boost] is turned on.
- You cannot change the [Equalizer] settings while [Bass Boost] is activated.

Related Topic

- [Browsing the music playback screen](#)
- [Presetting your equalizer settings](#)
- [Bass Boost settings](#)

[Notes on use](#)

4-529-726-11(1)



Copyright 2014 Sony Corporation

Digital Music Player
NWZ-B183/B183F

Presetting your equalizer settings

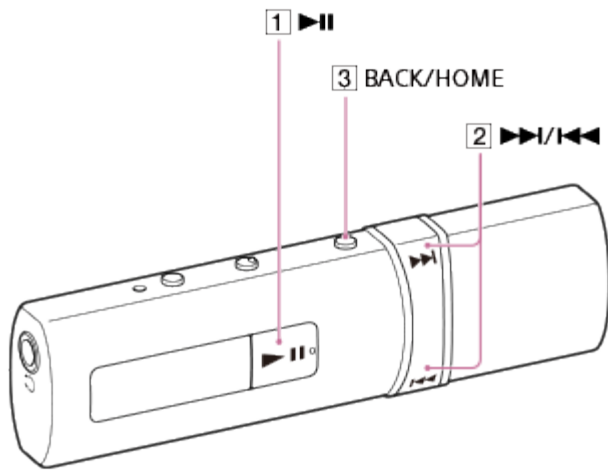
You can preset the values of the 5 band equalizer as a custom setting.



1. From the Home menu, select  [Settings].
2. Select [Music Settings] - [Equalizer] - [ Edit] under [Custom].
3. Press the **1** button to select a slider.
To go back to the sliders on the left, press the **3** button.
4. Press the **2** button to select the sound level (7 levels: -3 to +3).
5. Press the **1** button to confirm.

Related Topic

- [Customizing sound quality settings](#)

Notes on use

4-529-726-11(1)





Copyright 2014 Sony Corporation

Digital Music Player
NWZ-B183/B183F

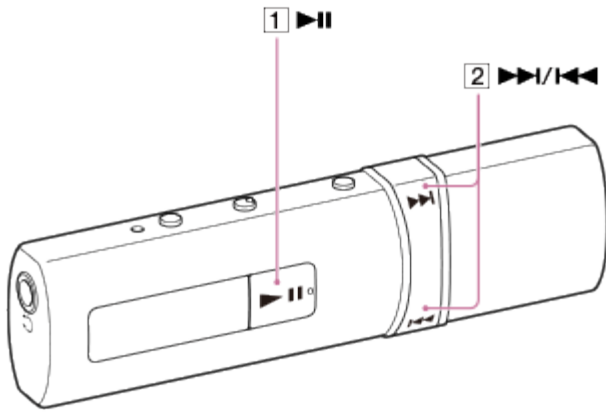
Listening to FM radio

Listen to FM radio on your Walkman. You cannot listen to FM radio without connecting the supplied headphones, as the cord of these headphones works as the antenna. Extend the cord as long as possible. (NWZ-B183F only)



1. From the Home menu, select  [FM Radio].
2. Press the  button to select [Manual Tune] or [Preset].
FM radio screen is displayed.
3. Press the  button to select the desired frequency or preset number.
To turn off FM radio, press the  button. [OFF] will be indicated.

Hint

- Preset numbers can only be used to select a broadcast station if one or more broadcast stations are saved as preset. Select  [Settings] - [FM Radio Settings] - [Auto Preset] - [Yes] to save a receivable broadcast station as preset by automatically.

Note

- The following functions cannot be used when listening to FM radio.
 - [Equalizer]
 - [Bass Boost]

Related Topic

- [Browsing the FM radio screen](#)

- [FM radio operations](#)
- [Presetting broadcast stations automatically](#)
- [Presetting broadcast stations manually](#)

[Notes on use](#)

4-529-726-11(1)

Copyright 2014 Sony Corporation

Digital Music Player
NWZ-B183/B183F

Browsing the FM radio screen

The following items are displayed on the FM radio screen. (NWZ-B183F only)

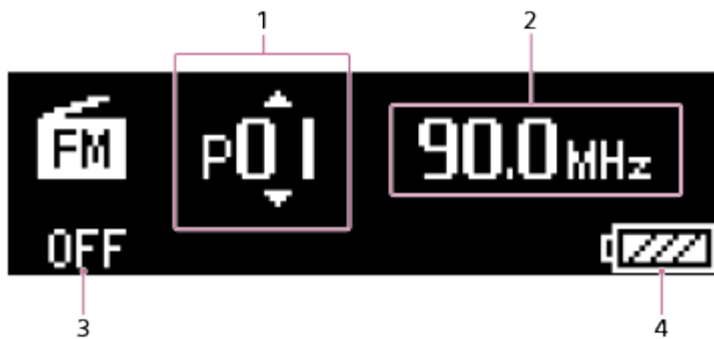

1. Preset number
2. Frequency
3. FM radio off indication
4. Battery status icon

Related Topic

- [Listening to FM radio](#)
- [FM radio operations](#)

Notes on use

4-529-726-11(1)

Copyright 2014 Sony Corporation

Digital Music Player
NWZ-B183/B183F

FM radio operations

The following operations are available on the FM radio screen. You cannot listen to FM radio without connecting the supplied headphones, as the cord of these headphones works as the antenna. Extend the cord as long as possible. (NWZ-B183F only)

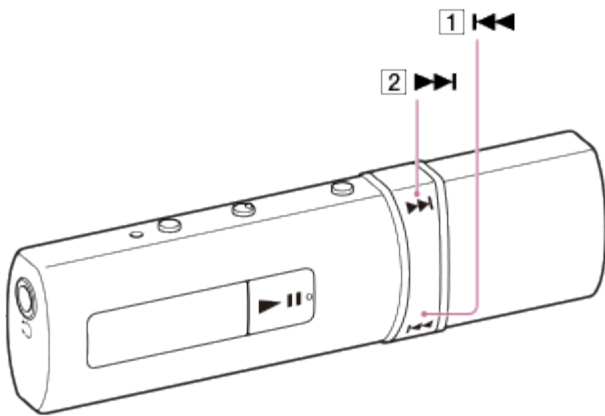



To select the previous or next frequency
Press the **1** or **2** button in the manual tuning mode.

To select the previous or next receivable station
Press and hold the **1** or **2** button in the manual tuning mode.

To select the previous or next preset number
Press the **1** or **2** button in the preset tuning mode.

Hint

- Preset numbers can only be used to select a broadcast station if one or more broadcast stations are saved as preset. Select  [Settings] - [FM Radio Settings] - [Auto Preset] - [Yes] to save a receivable broadcast station as preset by automatically.
- If the reception sensitivity is too strong and causes many unwanted broadcast stations to be received while searching, set the scan sensitivity to  [Settings] - [FM Radio Settings] - [Scan Sensitivity] - [Low Sensitivity].

Related Topic

- [Browsing the FM radio screen](#)

- [Listening to FM radio](#)
- [Presetting broadcast stations automatically](#)
- [Presetting broadcast stations manually](#)
- [Changing the FM radio scan sensitivity](#)

[Notes on use](#)

4-529-726-11(1)

Copyright 2014 Sony Corporation



Digital Music Player
NWZ-B183/B183F

Presetting broadcast stations automatically

You can use Auto Preset to automatically search for and preset broadcast stations that can be received in your area. You cannot listen to FM radio without connecting the supplied headphones, as the cord of these headphones works as the antenna. Make sure that the cord is extended as long as possible. (NWZ-B183F only)

1. From the Home menu, select  [Settings].
2. Select [FM Radio Settings] - [Auto Preset] - [Yes].

Hint

- If the reception sensitivity is too strong and causes many unwanted broadcast stations to be received while searching, set the scan sensitivity to [Low Sensitivity].
- You can preset up to 30 stations.

Note

- Using [Auto Preset] clears all previous presets.

Related Topic

- [Listening to FM radio](#)
- [Presetting broadcast stations manually](#)
- [Deleting preset broadcast stations](#)
- [Changing the FM radio scan sensitivity](#)

Notes on use

4-529-726-11(1)





Copyright 2014 Sony Corporation

Digital Music Player
NWZ-B183/B183F

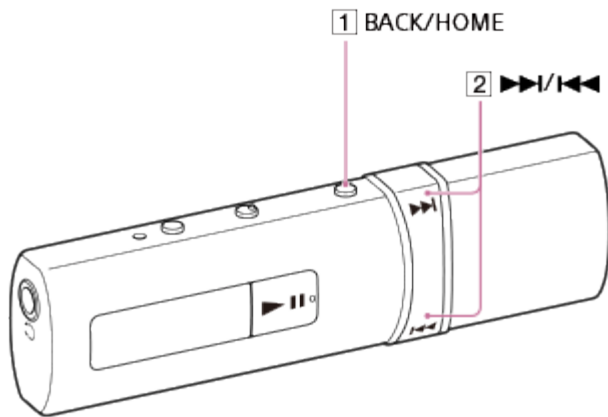
Presetting broadcast stations manually

You can manually preset receivable broadcast stations. You cannot listen to FM radio without connecting the supplied headphones, as the cord of these headphones works as the antenna. Make sure that the cord is extended as long as possible. (NWZ-B183F only)



1. From the Home menu, select  [FM Radio].
2. Press the  button to select [Manual Tune].
FM radio screen is displayed.
3. Press the  button to select the desired frequency.
4. Press the  button - [Add Preset] - desired preset number.
The frequency you have selected is preset to the selected preset number.

Hint

- You can preset up to 30 stations.

Related Topic

- [Listening to FM radio](#)
- [Presetting broadcast stations automatically](#)
- [Deleting preset broadcast stations](#)

Digital Music Player
NWZ-B183/B183F

Deleting preset broadcast stations

You can delete preset broadcast stations. (NWZ-B183F only)

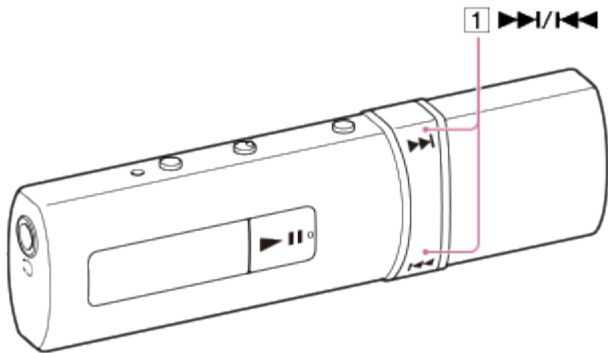

1. From the Home menu, select  [FM Radio].
2. Press the  button to select [Delete Preset] - desired preset number - [Yes].

Related Topic

- [Listening to FM radio](#)
- [Presetting broadcast stations automatically](#)
- [Presetting broadcast stations manually](#)
- [FM radio operations](#)

Notes on use

4-529-726-11(1)

Copyright 2014 Sony Corporation

Digital Music Player
NWZ-B183/B183F

Changing the FM radio scan sensitivity

Sometimes the reception sensitivity may be too strong when receiving an FM radio broadcast station, causing many unwanted broadcast stations to be received. In such cases, set the scan sensitivity to low. (NWZ-B183F only)

1. From the Home menu, select  [Settings].
2. Select [FM Radio Settings] - [Scan Sensitivity] - [Low Sensitivity].

Related Topic

- [Listening to FM radio](#)
- [Presetting broadcast stations automatically](#)

Notes on use

4-529-726-11(1)









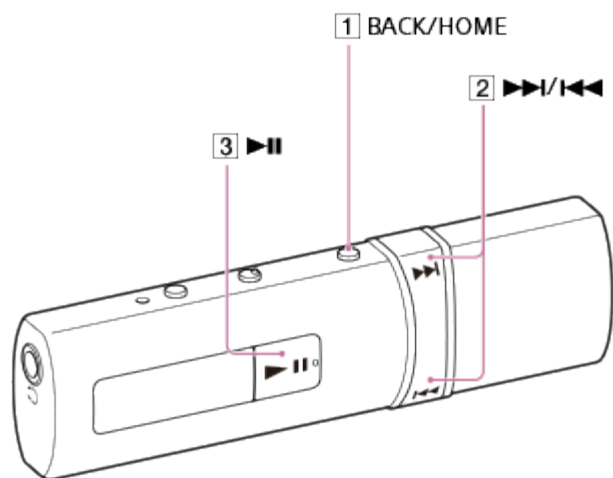

Copyright 2014 Sony Corporation

Digital Music Player
NWZ-B183/B183F

Making FM radio recordings

You can record FM radio programs on your Walkman. (NWZ-B183F only)



1. From the Home menu, select  [FM Radio].
2. Press the  button to select [Manual Tune] or [Preset], and then press the  button.
FM radio screen is displayed.
3. Press the  button to select the desired frequency or preset number.
4. Press the  button, and then the  button to select [Record]. Confirm by pressing the  button.
Your Walkman enters recording standby mode.
5. Press the  button.
Recording starts.
To pause recording, press the  button. Press it again to resume recording.
6. Press the  button to stop recording.
The recording is saved as a file named [FRnnnn] (*1) in the “RECORD” - “FM” folder on your Walkman.

(*1) File names are automatically assigned from [FR0001] to [FR9999].

Hint

- Recording in areas where the reception is poor may result in noise occurring in the recording. Record in areas where the reception is strong.

- The programs and sound files recorded with your Walkman can be played back on the Walkman or on a computer.

Note

- The programs are recorded in monaural sound.
- If you rename files of the “RECORD” folder on your computer, or put files which have been imported to your computer back into the “RECORD” folder, you may not be able to play them on your Walkman.

Related Topic

- [Playing FM radio recordings](#)

Notes on use

4-529-726-11(1)

Copyright 2014 Sony Corporation

Digital Music Player
NWZ-B183/B183F

Playing FM radio recordings

You can play recorded FM radio programs on your Walkman. (NWZ-B183F only)

1. From the Home menu, select  [FM Radio].
2. Select [Play Recording] - desired file name.

Hint

- To play all recorded FM radio programs, select  [FM Radio] - [Play Recording] - [All Recordings].

Related Topic

[Deleting FM radio recordings](#)

Notes on use

4-529-726-11(1)

Copyright 2014 Sony Corporation



Digital Music Player
NWZ-B183/B183F

Deleting FM radio recordings

You can delete recorded FM radio programs from your Walkman. (NWZ-B183F only)

1. From the Home menu, select  [FM Radio].
2. Select [Delete Recording] - desired file name - [Yes].
The selected FM radio program is deleted.

Hint

- To delete all recorded FM radio programs, select  [FM Radio] - [Delete Recording] - [Delete All] - [Yes].

[Notes on use](#)

4-529-726-11(1)

Copyright 2014 Sony Corporation



Digital Music Player
NWZ-B183/B183F

Limiting the volume

You can use AVLS (Automatic Volume Limiter System) to limit the maximum volume. This prevents the volume from getting too high and disturbing others, causing discomfort to your ears or preventing you from hearing sounds around you, and allows you to listen at a more comfortable volume.

1. From the Home menu, select  [Settings].
2. Select [Common Settings] - [AVLS (Volume Limit)] - desired setting.

[Notes on use](#)

4-529-726-11(1)

Copyright 2014 Sony Corporation



Digital Music Player
NWZ-B183/B183F

Setting the operation sound

You can turn the operation sounds of your Walkman on or off.

1. From the Home menu, select  [Settings].
2. Select [Common Settings] - [Beep Settings] - desired setting.

Note

- Error beeps and guidance remain on regardless of the setting in [Beep Settings].

[Notes on use](#)

4-529-726-11(1)

Copyright 2014 Sony Corporation



Setting the screen off timer

You can set the time after which the screen is turned off when there are no operations.

1. From the Home menu, select  [Settings].
2. Select [Common Settings] - [Screen Off Timer] - desired setting.

Note

- The screen does not turn off in the following situations:
 - While accessing, creating or restoring databases
 - While scanning FM radio broadcast stations
 - While presetting FM radio broadcast stations automatically

[Notes on use](#)

4-529-726-11(1)

Copyright 2014 Sony Corporation



Digital Music Player
NWZ-B183/B183F

Adjusting the screen brightness

You can set the display brightness to one of 5 levels.

1. From the Home menu, select  [Settings].
2. Select [Common Settings] - [Brightness] - desired setting.

Hint

- Regardless of the brightness setting, the brightness of the screen may be low while displaying some of the screens such as the USB connection screen and charging screen.

[Notes on use](#)

4-529-726-11(1)

Copyright 2014 Sony Corporation



Digital Music Player
NWZ-B183/B183F

Displaying your Walkman information

Display information such as model name and software version.

1. From the Home menu, select  [Settings].
2. Select [Unit Information].

[Notes on use](#)

4-529-726-11(1)

Copyright 2014 Sony Corporation



Digital Music Player
NWZ-B183/B183F

Warning

Below is important information for using your Walkman. Be sure to follow these instructions.

- Be sure not to short-circuit the terminals of your Walkman with metallic objects.
- Do not spill water on your Walkman or allow any foreign object to enter it. This may cause fire or electric shock. If this occurs, turn off the Walkman immediately, disconnect the Walkman from your computer, and consult your nearest Sony dealer or Sony Service Center.
- Do not place your Walkman in fire.
- Do not take apart or remodel your Walkman. Doing so can result in electric shock. Consult your nearest Sony dealer or Sony Service Center for exchange of rechargeable batteries, internal checks or repair.
- Do not put any heavy object on top of your Walkman or apply a strong shock to it. This may cause malfunction or damage.

[Notes on use](#)

4-529-726-11(1)

Copyright 2014 Sony Corporation



Digital Music Player
NWZ-B183/B183F

Caution

Notes on use

The following descriptions are important for using your Walkman. Be sure to follow the instructions below.

- Do not touch the rechargeable battery with bare hands if it is leaking. Consult your nearest Sony dealer if the battery has leaked, as battery liquid may remain in your Walkman. If the liquid gets into your eyes, do not rub your eyes as this may lead to blindness. Wash out your eyes with clean water and consult a doctor.
If the liquid gets onto your body or clothes, wash it off immediately. Failure to do so may cause burns or injury. Consult a doctor if you are burned or injured by the liquid from the battery.
- If your Walkman causes interference to radio or television reception, turn the Walkman off and move it away from the radio or television.
- Mild tingling may be felt on your ears in particularly dry air conditions. This is a result of static electricity accumulated in the body, and is not a malfunction of your Walkman.
This effect can be minimized by wearing clothes made from natural materials.
- When using a strap (not supplied), be careful to avoid catching it on objects you pass by.
Also, be careful not to swing your Walkman by the strap to avoid bumping people.
- Refrain from using your Walkman as requested by in-flight announcements during takeoff or landing in an aircraft.
- If you see lightning or hear thunder, take off the headphones immediately and refrain from using your Walkman.
- If you experience an allergic reaction to the supplied headphones, stop using them immediately and contact a doctor.

Notes on usage environment

- Never use your Walkman where it will be subjected to extreme light, temperatures, humidity or vibration. For example, never leave the Walkman in a car parked in the sun or in direct sunlight. It may become discolored, distorted or damaged.
- Do not leave your Walkman in a place subject to excessive dust.
- Do not leave your Walkman on an unstable surface or in an inclined position.

Notes on handling your Walkman

- When unplugging the headphones from your Walkman, make sure to hold the headphone plug. Pulling by the headphone cord itself may damage it.
- Do not apply strong force to the surface of the Display. This may cause a distortion in colors or brightness, or cause a malfunction of the Display.
- Be sure to follow the precautions below when using your Walkman. Failure to do so may warp the casing or cause the Walkman to malfunction.
 - Do not sit down with the Walkman in your back pocket.



–Do not put your Walkman in a bag with the headphones/earphones cord wrapped around it and subject the bag to strong impact.



Notes on protecting your Walkman from getting wet

- Do not expose your Walkman to water. The Walkman is not waterproof. Be sure to follow the precautions below.

- Be careful not to drop your Walkman into a sink or other container filled with water.
- Do not use your Walkman in humid locations or wet weather such as rain or snow.
- Do not get your Walkman wet.

If you touch your Walkman with wet hands or put the Walkman in a damp article of clothing, the Walkman may get wet, which may cause a malfunction.



Notes on use

4-529-726-11(1)

Copyright 2014 Sony Corporation



Digital Music Player
NWZ-B183/B183F

Notice for users

- Recorded songs are limited to private use only. Use of songs beyond this limit requires the permission of the copyright holders.
- Sony is not responsible for incomplete recording/downloading or damaged data due to problems with your Walkman or computer.
- Heat may build up in your Walkman while charging if it is used for an extended period of time.
- Note that condensation may form temporarily in cases such as when your Walkman is moved quickly from a low-temperature environment to a high temperature environment, or used in a room where a heater has just been turned on. Condensation is a phenomenon where moisture in the air adheres to surfaces such as metal panels and then changes to liquid.

If condensation forms in your Walkman, leave it turned off until the condensation disappears.

If you use the Walkman with condensation present, a malfunction may result.

- If you use your Walkman in a cold location, images may appear with black bands around them. This is not a malfunction of the Walkman.

About sample data (*1)

Sample data is pre-installed on your Walkman.

If you delete the sample data, you cannot restore it, and we will not supply any replacement data.

(*1) In some countries/regions some sample data is not installed.

[Notes on use](#)

4-529-726-11(1)

Copyright 2014 Sony Corporation

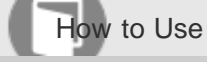

Digital Music Player
NWZ-B183/B183F

Notes on headphones

Road safety

Avoid listening with your headphones in situations where hearing must not be impaired.

Preventing hearing damage

Avoid using the headphones at a high volume. Hearing experts advise against continuous, loud and extended play. If you experience a ringing in your ears, reduce the volume or discontinue use.

Do not turn the volume up high all at once, especially when using headphones. Turn up the volume gradually to avoid excessive levels hurting your ears.

Consideration for others

Keep the volume at a moderate level. This will allow you to hear outside sounds and to be considerate to the people around you.

About the in-ear headphones

The earbuds seal your ears. Therefore, be aware that there is a risk of damage to your ears or eardrums if strong pressure is applied to the earbuds, or the earbuds are suddenly removed from your ears. After use, be sure to take the earbuds off your ears gently.

[Notes on use](#)

4-529-726-11(1)

Copyright 2014 Sony Corporation



Digital Music Player
NWZ-B183/B183F

Notes on the software

- Copyright laws prohibit reproducing the software or the manual accompanying it in whole or in part, or renting the software without the permission of the copyright holder.
- In no event will Sony be liable for any financial damage, or loss of profits, including claims made by third parties, arising out of the use of the software supplied with your Walkman.
- The software supplied with your Walkman cannot be used with equipment other than that to which it is designated.
- Please note that, due to continued efforts to improve quality, the software specifications may be changed without notice.
- Operation of your Walkman with software other than that supplied is not covered by the warranty.
- The explanations in this manual assume that you are familiar with the basic operations of your computer.
For details on the use of your computer and operating system, please refer to the respective manuals.

[Notes on use](#)

4-529-726-11(1)

Copyright 2014 Sony Corporation



Digital Music Player
NWZ-B183/B183F

Customer support website

If you have any questions or issues with your Walkman, or would like information on compatible items with the Walkman, visit one of the following websites.

For customers in the USA:

<http://www.sony.com/walkmansupport>

For customers in Canada:

English

<http://www.sony.ca/ElectronicsSupport/>

French

<http://www.sony.ca/ElectronicsSupport/>

For customers in Latin America:

<http://www.sony-latin.com/index.crp>

For customers in Europe:

<http://support.sony-europe.com/dna/wm/>

For customers in Asia/Oceania/Middle East/Africa:

English

<http://www.sony-asia.com/support>

Korean

<http://scs.sony.co.kr/walkman/>

Simplified Chinese

<http://service.sony.com.cn/KB/>

Traditional Chinese

<http://service.sony.com.tw/>

For customers who purchased the overseas models:

<http://www.sony.co.jp/overseas/support/>



Digital Music Player
NWZ-B183/B183F

Specifications

Display

Size/resolution

0.9-inch (2.26 cm) 128 x 36 Pixels

Panel type

OLED

Interface

USB

Hi-Speed USB (USB 2.0 compliant)

Headphone

Stereo mini-jack

FM radio

FM Frequency range

87.5 MHz to 108.0 MHz

Antenna

Headphone cord antenna

Output (headphones)

Frequency response

20 Hz to 20,000 Hz (when playing data file, single signal measurement)

Sound Effects

5 Band equalizer (None/Heavy/Pop/Jazz/Unique/Custom) & Bass Boost

Power Source

Built-in Rechargeable lithium-ion Battery

USB power (from a computer via a USB connector of the player)

Charging Time

USB-based charging

Approx. 70 minutes

Operating temperature

5 °C to 35 °C (41 °F to 95 °F)

Dimensions

w/h/d, projecting parts not included

84.5 mm x 22.2 mm x 13.4 mm (3 3/8 inches x 7/8 inches x 17/32 inches)

w/h/d

84.8 mm x 23.6 mm x 15.3 mm (3 3/8 inches x 15/16 inches x 8/15 inches)

Mass

30 g (1.1 oz)

Capacity (User available capacity) (*1)

NWZ-B183: 4 GB

NWZ-B183F: 4 GB

(*1) Available capacity may vary. A portion of the memory is used for data management functions.

[Notes on use](#)

4-529-726-11(1)

Copyright 2014 Sony Corporation



Digital Music Player
NWZ-B183/B183F

Battery life

The time below may differ depending on ambient temperature or the status of use.

Battery life (continuous playback)

Actual battery life may vary depending on settings. The estimated battery usage hours shown below are based on typical usage conditions with “Settings for battery life measurement” as below.

Music (NWZ-B183/B183F)

MP3 128 kbps

approx. 20 Hrs

WMA 128 kbps

approx. 15 Hrs

FM (NWZ-B183F)

approx. 6 Hrs

FM REC (NWZ-B183F)

approx. 3 Hrs

Note

- Even if the player is turned off for an extended period, a small amount of battery power is still consumed.
- Battery life may vary depending on volume setting, conditions of use and ambient temperature.

Settings for battery life measurement

Common Settings

Screen Off Timer (*1): 15 Seconds (default setting: 30 Seconds)

Brightness: 1 (default setting: 3)

Music Settings

Equalizer: Off (default setting: Off)

Bass Boost: Bass Boost Off (default setting: Bass Boost On)

(*1) The longer the waiting time, the shorter the battery life for continuous music playback.



Digital Music Player
NWZ-B183/B183F

Maximum recordable number of songs and time (Approx.)

The approximate times are based on the case in which you transfer or record only 4 minute songs (not including videos and photos) in the MP3 format. Other playable audio file format song numbers and times may differ from MP3 format.

Number

NWZ-B183F (4 GB)

128 kbps: Approx. 890 songs

NWZ-B183 (4 GB)

128 kbps: Approx. 890 songs

Time [H:M]

NWZ-B183F (4 GB)

128 kbps: Approx. 59 hr. 20 min.

NWZ-B183 (4 GB)

128 kbps: Approx. 59 hr. 20 min.

[Notes on use](#)

4-529-726-11(1)

Copyright 2014 Sony Corporation

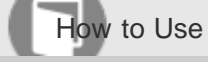

Digital Music Player
NWZ-B183/B183F

Maximum recordable time (Approx.)

The times below are estimated for the case where only FM (NWZ-B183F only).
The time may differ, depending on the conditions under which your Walkman is used.

Time [H:M]

NWZ-B183F (4 GB)

MS-ADPCM: Approx. 100 hr.

[Notes on use](#)

4-529-726-11(1)

Copyright 2014 Sony Corporation

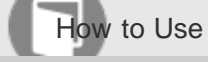

Digital Music Player
NWZ-B183/B183F

Supported formats

Music (Music player)

Audio Formats (Codec)

MP3

Media File format: MP3 (MPEG-1 Layer3) file format

File extension: .mp3

Bit rate: 32 to 320 kbps (Supports variable bit rate (VBR))

Sampling frequency (*2): 32, 44.1, 48 kHz

WMA (*1)

Media File format: ASF file format

File extension: .wma

Bit rate: 32 to 192 kbps (Supports variable bit rate (VBR))

Sampling frequency (*2) : 44.1 kHz

(*1) Copyright protected WMA/WMV files cannot be played back.

(*2) Sampling frequency may not correspond to all encoders.

[Notes on use](#)

4-529-726-11(1)

Copyright 2014 Sony Corporation



Digital Music Player
NWZ-B183/B183F

System requirements

- Computer

- Windows Vista® Home Basic (Service Pack 2 or later)
- Windows Vista® Home Premium (Service Pack 2 or later)
- Windows Vista® Business (Service Pack 2 or later)
- Windows Vista® Ultimate (Service Pack 2 or later)
- Windows® 7 Starter (Service Pack 1 or later)
- Windows® 7 Home Basic (Service Pack 1 or later)
- Windows® 7 Home Premium (Service Pack 1 or later)
- Windows® 7 Professional (Service Pack 1 or later)
- Windows® 7 Ultimate (Service Pack 1 or later)
- Windows® 8
- Windows® 8 Pro
- Windows® 8.1
- Windows® 8.1 Pro

Not supported by OSs other than above. Pre-installed only supported.

- CPU: 1 GHz processor
- RAM: 1 GB or more (2 GB RAM required for Windows 8 64-bit)
- Hard Disk Drive / Solid State Drive: 600 MB or more of available space
- Internet Explorer 7 or later
- Windows Media Player 11 for Windows Vista, Windows Media Player 12 for Windows 7, Windows 8 and Windows 8.1

We do not guarantee operation for all computers even if they meet the above System Requirements.

Not supported by the following environments:

- Personally constructed computers or operating systems
- An environment that is an upgrade of the original manufacturer-installed operating system
- Multi-boot environment
- Mac OS

Design and specifications are subject to change without notice.

[Notes on use](#)

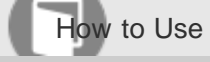

Digital Music Player
NWZ-B183/B183F

Contents

List of accessories and manuals supplied with your Walkman.

- Walkman (1)
- Headphones (1)
- Quick Start Guide

Design and specifications are subject to change without notice.

[Notes on use](#)

4-529-726-11(1)

Copyright 2014 Sony Corporation

Digital Music Player
NWZ-B183/B183F

What can I do to solve a problem?

If your Walkman does not function as expected, try the following steps to resolve the issue.

Before resetting your Walkman, disconnect the Walkman from your computer and check that no content such as music is being played back, otherwise the data may be damaged. You can then reset the Walkman safely.

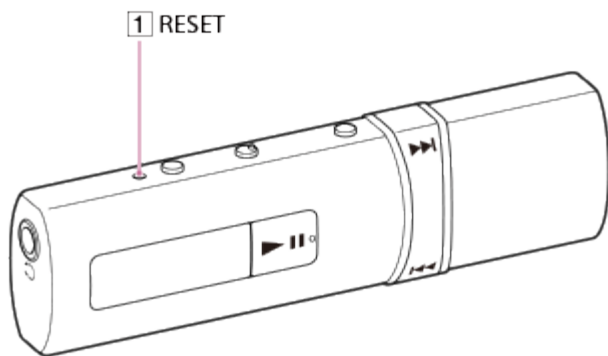

1. Check the topic on the issue in “Troubleshooting.”
2. Connect your Walkman to your computer to charge the battery.
You may be able to resolve some issues by charging the battery.
3. Press the **1** button with a pen or paper clip, etc. to reset your Walkman.
4. Check information on the issue in the help of the software having problems.
5. Look up information on the issue on one of the customer support websites.
6. If the approaches listed above fail to resolve the issue, consult your nearest Sony dealer.

Note

- Data will not be deleted, nor any settings will not be reset by resetting.

Related Topic

- [Charging the battery](#)
- [Resetting your Walkman](#)
- [Customer support website](#)

Digital Music Player
NWZ-B183/B183F

Your Walkman does not operate or the power does not turn on.

- If you transfer a lot of content such as music to your Walkman at once, it will take time to build the database in the Walkman. Therefore it will take more than 1 minute until the Walkman becomes operable again after you disconnect the Walkman from your computer.
- If the HOLD switch is set to the HOLD position, slide the switch to the opposite position.
- If your Walkman contains moisture condensation, wait a few hours to let the Walkman dry out.
- If the remaining battery power is low or insufficient, charge the battery.
- You cannot operate your Walkman while it is connected to a computer. Disconnect the Walkman from a computer.
- If your Walkman still does not operate after charging the battery, press the RESET button with a pen or a paper clip, etc. to reset the Walkman.

Related Topic

- [Parts and controls](#)
- [Charging the battery](#)
- [Resetting your Walkman](#)

[Notes on use](#)

4-529-726-11(1)

Copyright 2014 Sony Corporation



Digital Music Player
NWZ-B183/B183F

Your Walkman does not work properly.

- Your Walkman may not work properly if the USB device (e.g. computer) to which it is connected is turned on or off without disconnecting the Walkman.
Reset the Walkman by pressing the RESET button with a pen or a paper clip, etc.

Related Topic

[Resetting your Walkman](#)

[Notes on use](#)

4-529-726-11(1)

Copyright 2014 Sony Corporation



Digital Music Player
NWZ-B183/B183F

Your Walkman power turns off or on automatically.

- If a malfunction occurs, your Walkman turns off and then on again automatically.

[Notes on use](#)

4-529-726-11(1)

Copyright 2014 Sony Corporation

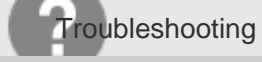

Digital Music Player
NWZ-B183/B183F

I want my Walkman screen to stay on longer before it turns off automatically.

- You can set the screen off timer settings in [Screen Off Timer].

Related Topic

- [Setting the screen off timer](#)

[Notes on use](#)

4-529-726-11(1)

Copyright 2014 Sony Corporation



Digital Music Player
NWZ-B183/B183F

A drink (water, coffee, etc.) was spilled on your Walkman, or the Walkman was washed in the washing machine.

- If you spill a drink on your Walkman or wash it in a washing machine, liquid may get inside the Walkman. Stop using the Walkman immediately and consult your nearest Sony dealer.

Related Topic

A small black circle icon positioned to the left of the text.
[Customer support website](#)

[Notes on use](#)

4-529-726-11(1)

Copyright 2014 Sony Corporation



Digital Music Player
NWZ-B183/B183F

I want to backup the content such as music saved on my Walkman.

- Connect to a computer and copy the files onto the computer.

Related Topic

- [Transferring content using Explorer](#)

Notes on use

4-529-726-11(1)

Copyright 2014 Sony Corporation

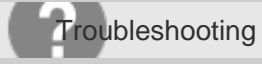

Digital Music Player
NWZ-B183/B183F

I want to find the product name (model name) of my Walkman.

- The model name is the alphabetical name that starts with NW that is printed on the back of your Walkman. If the Walkman is inside a case, you need to remove it from the case to find the name.

Related Topic

• [Displaying your Walkman information](#)

[Notes on use](#)

4-529-726-11(1)

Copyright 2014 Sony Corporation

An alarm (beep) is heard and the message [Check the volume level] is displayed.

- An alarm (beep) and a warning [Check the volume level] are meant to protect your ears when you turn the volume up to a level which is harmful for your ears for the first time. You can cancel the alarm and warning by pressing any button.
- You can turn up the volume after canceling the alarm and warning.
- After the initial warning, the alarm and warning repeat for every 20 cumulative hours that the volume is set to a level which is harmful for your ears; when this happens, the volume is turned down automatically.

Related Topic

- [Volume operation \(Only for countries/areas complying with European and Korean Directives\)](#)

Notes on use

4-529-726-11(1)

Copyright 2014 Sony Corporation



Digital Music Player
NWZ-B183/B183F

There is no sound.

- Check whether the volume level is set to zero.
- Check whether the plug is inserted firmly in the headphone jack. Sound will be impaired if the headphones are not connected properly. Insert the plug until it clicks into place.
- If the plug is dirty, wipe it clean with a soft dry cloth.
- If the problem persists after performing the remedies above, use a pen or paper clip, etc. to press the RESET button and reset your Walkman.

Related Topic

- [Parts and controls](#)
- [Using the HOLD switch](#)
- [Playing music](#)
- [Resetting your Walkman](#)

[Notes on use](#)

4-529-726-11(1)

Copyright 2014 Sony Corporation



Digital Music Player
NWZ-B183/B183F

The content such as music suddenly stops during playback.

- The remaining battery power is low or depleted.
- The content may not be supported on your Walkman. Select and play back other content.

Related Topic

• [Supported formats](#)

[Notes on use](#)

4-529-726-11(1)

Copyright 2014 Sony Corporation

Noise is generated.

- When using near a device that emits radio waves such as a mobile phone, move your Walkman away from the device.
- The content such as music on your Walkman may be corrupted.
Connect your Walkman to a computer, use Windows Explorer to delete the content in which noise has occurred from the Walkman. After you have deleted the corrupted content, transfer the content again from the computer to the Walkman. Do not perform any other tasks on the computer when transferring content to the Walkman. Doing so may cause the content to be corrupted.
- If the plug is dirty, wipe it clean with a soft dry cloth.

Related Topic

- [Deleting content from your Walkman using Explorer](#)
- [Transferring content using Explorer](#)

[Notes on use](#)

4-529-726-11(1)

Copyright 2014 Sony Corporation

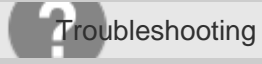

Digital Music Player
NWZ-B183/B183F

Volume cannot be turned up, or the volume remains low when the playback volume is turned up.

- If the HOLD switch is in the HOLD position, slide it to the opposite position.
- If the AVLS (Volume Limit) setting is activated, deactivate it.

Related Topic

- [Parts and controls](#)
- [Using the HOLD switch](#)
- [Limiting the volume](#)

[Notes on use](#)

4-529-726-11(1)

Copyright 2014 Sony Corporation



Digital Music Player
NWZ-B183/B183F

Sound can only be heard from one side of the headphones.

- Sound will not be output properly if the plug is not inserted correctly into the jack. Insert the headphone plug until it clicks into place.
- Wires inside the headphone cable may be broken due to unnecessary force, etc. being applied to the cable. In this case, contact your nearest Sony dealer for repairs.

[Notes on use](#)

4-529-726-11(1)

Copyright 2014 Sony Corporation



Digital Music Player
NWZ-B183/B183F

Sound is interrupted or skips.

- The sound may be interrupted or skip depending on the environment where your Walkman is used or the settings of your Walkman.

Following the procedures below may reduce the amount of skipping or interruptions.

- Set all sound quality settings to off.

Related Topic

- [Customizing sound quality settings](#)

[Notes on use](#)

4-529-726-11(1)

Copyright 2014 Sony Corporation

Digital Music Player
NWZ-B183/B183F

Cannot charge the Walkman.

- The battery cannot be charged while “” is displayed because the protection function is engaged. Charge the battery within the ambient temperature range of 5 °C to 35 °C.
- You need to turn the computer power on in order to charge your Walkman. Check whether the computer is in standby (sleep) or hibernation status.
- Check that the USB connection to the computer is made properly.
- There may be bad electrical contact in the connector. Disconnect your Walkman, and then reconnect it.
- Your Walkman may not be able to connect properly to your computer when using a USB hub. Connect the Walkman directly to the USB connector on your computer.
- Check whether the operating system and operating system version installed on the computer are compatible with your Walkman.
- The battery may have deteriorated if you have not used your Walkman for more than a year. Contact your nearest Sony dealer.
- If the remedies above do not solve the problem, use a pen or paper clip, etc. to press the RESET button and reset your Walkman, and then connect again using USB.

Related Topic

- [Parts and controls](#)
- [Connecting to a computer via USB](#)
- [Resetting your Walkman](#)
- [Customer support website](#)

[Notes on use](#)

4-529-726-11(1)

Copyright 2014 Sony Corporation

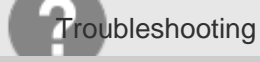

Digital Music Player
NWZ-B183/B183F

What is the battery life of the built-in rechargeable battery?

- This will differ depending on the environment where your Walkman is used, but on average the built-in rechargeable battery can be charged approximately 500 times. The battery life becomes shorter and capacity is reduced as a result of the number of times it is recharged or used, and the environment in which it is used. When the usable battery life is half the usual time even when the battery is fully charged, the battery should be replaced.
- Consult your nearest Sony dealer for more details on the life of the built-in battery.

Related Topic

● [Customer support website](#)

[Notes on use](#)

4-529-726-11(1)

Copyright 2014 Sony Corporation

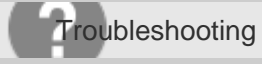

Digital Music Player
NWZ-B183/B183F

The rechargeable battery needs to be replaced.

- To replace rechargeable batteries, your Walkman needs to be taken apart professionally. Do not take apart the Walkman by yourself.
- Consult your nearest Sony dealer or Sony Service Center for replacement of rechargeable batteries.

Related Topic

[Customer support website](#)

[Notes on use](#)

4-529-726-11(1)

Copyright 2014 Sony Corporation

The battery duration is short.

- If your Walkman is used in an environment where the temperature is below 5 °C, the battery life becomes shorter due to characteristics of the battery. This is not a malfunction.
- Charge the battery until it is full.
- You can preserve the battery life and get more use from each charge by changing your Walkman settings and managing the power appropriately.
- Depending on the environment in which your Walkman is used, the battery may deteriorate if it is not used for over a year. Contact your nearest Sony dealer.
- If the usable battery life is half that when new even after sufficiently charging the battery, your battery may have deteriorated. Contact your nearest Sony dealer.

Related Topic

- [Charging the battery](#)
- [Extending the battery life](#)
- [Customer support website](#)

[Notes on use](#)

4-529-726-11(1)

Copyright 2014 Sony Corporation

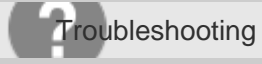

Digital Music Player
NWZ-B183/B183F

What is the standard battery duration?

- For details on the battery duration, see “Battery life.”

Related Topic

[Battery life](#)

[Notes on use](#)

4-529-726-11(1)

Copyright 2014 Sony Corporation

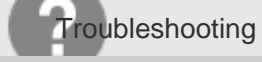

Digital Music Player
NWZ-B183/B183F

How long does it take to charge the battery?

- For details on the charging time, see “Charging time” in the “Specifications.”

Related Topic

● [Specifications](#)

[Notes on use](#)

4-529-726-11(1)

Copyright 2014 Sony Corporation

The computer does not recognize your Walkman.

- If the remaining battery power is low, charge the battery.
- When you use your Walkman for the first time, or if you have not used the Walkman for a long time, it may take a few minutes to be recognized by the computer. Check that the computer recognizes the Walkman after you have connected it to the computer for about 10 minutes.
- Make sure that the USB connection to the computer is made properly and securely.
- Your Walkman may not be recognized if connected via a USB hub. Connect the Walkman directly to the USB connector on your computer.
- If the approaches listed above fail to resolve the issue, press the RESET button with a pen or a paper clip, etc. to reset your Walkman then try the USB connection again.

Related Topic

- [Charging the battery](#)
- [Connecting to a computer via USB](#)
- [Resetting your Walkman](#)

[Notes on use](#)

4-529-726-11(1)

Copyright 2014 Sony Corporation



Digital Music Player
NWZ-B183/B183F

Even if you use “Safely Remove Hardware” on the computer, [Connecting USB] remains displayed on your Walkman screen.

- When using Windows Vista, Windows 7, Windows 8 or Windows 8.1, the Walkman screen remains as [Connecting USB]. This is not a problem provided that the "Safely Remove Hardware" operation is complete. Disconnect your Walkman from the computer.

[Notes on use](#)

4-529-726-11(1)

Copyright 2014 Sony Corporation

Digital Music Player
NWZ-B183/B183F

Content such as music cannot be transferred from the computer to your Walkman.

- Check that the USB connection to the computer is made properly.
- You may not be able to transfer content when using a USB hub. Connect directly to the USB connector on your computer.
- There is not enough free space in your Walkman, or the number of files has exceeded the maximum number of transferable files. Delete any unnecessary content to increase free space. For details on the recordable number, see following.
 - “Maximum recordable number of songs and time (Approx.)”
- Songs with a limited playing period or playing count may not be transferred due to restrictions set by copyright holders. For details on the settings of each audio file, contact the distributor.
- Some of the content on your Walkman may be damaged. Return required content to the computer and initialize (format) the Walkman.
- If the software is not compatible with your Walkman, install compatible software and use the compatible software to transfer content.
- You may be attempting to transfer corrupted content. Delete the content that cannot be transferred from the computer, and import this content into the computer again. Do not perform any other tasks on the computer when transferring content to your computer. Doing so may cause the content to corrupt.
- You may be attempting to transfer a file that is not in playable format. Check the “Supported formats.”
- Transferring may be stopped due to noise such as static electricity accumulated in the computer. This happens to protect data information. Disconnect your Walkman, and then reconnect it.

Related Topic

- [Connecting to a computer via USB](#)
- [Maximum recordable number of songs and time \(Approx.\)](#)
- [Resetting your Walkman](#)
- [Resetting to the factory settings](#)
- [Formatting memory](#)
- [Supported formats](#)



Digital Music Player
NWZ-B183/B183F

Only a small amount of content such as music can be transferred to your Walkman.

- There is not enough free memory space on your Walkman. Delete any unnecessary content to increase free space.
- If content that cannot be played on your Walkman is stored on the Walkman, less content can be transferred. Transfer content other than that which you want to play on the Walkman back to the computer in order to increase the available space.

Related Topic

- [Maximum recordable number of songs and time \(Approx.\)](#)

[Notes on use](#)

4-529-726-11(1)

Copyright 2014 Sony Corporation



Digital Music Player
NWZ-B183/B183F

Your Walkman becomes unstable when it is connected to the computer.

- Your Walkman may be unstable if it is connected using a USB hub or USB extension cable. Connect the Walkman directly to the USB connector on your computer.

[Notes on use](#)

4-529-726-11(1)

Copyright 2014 Sony Corporation

Digital Music Player
NWZ-B183/B183F

Cannot play content such as music transferred to your Walkman.

- If the remaining battery power is low or insufficient, charge the battery. If your Walkman still does not operate after charging the battery, press the RESET button with a pen or a paper clip, etc. to reset your Walkman.
- The data hierarchy levels of the content transferred by drag-and-drop may not be correct. Place them in the appropriate folder and hierarchy.
- Transferred files are not in a playable format. See “Supported formats” for details on playable formats.
- Content that is not recorded in playable formats is not recognized by your Walkman and will not be displayed in the lists.
- Formatting your Walkman failed to complete, or you formatted the Walkman on the computer. Retry formatting the built-in flash memory of your Walkman.
- The transferred content may be damaged. Delete the unplayable content from your Walkman and retransfer it, or delete the content from your computer and reimport it. When you import content, make sure that no other tasks are running on your computer until importing is completed. Otherwise, the content may be damaged.
- If you change the file names or location of the content such as music that was transferred from your computer to your Walkman, the content may not be recognized by the Walkman. Return it to the correct name and location.
- If you have initialized (formatted) the built-in flash memory of your Walkman using Windows Explorer, initialize (format) it again on the Walkman.
- The USB connection to the computer may have been disconnected while transferring content. Transfer usable files back to your computer and initialize (format) the built-in flash memory on your Walkman.

Related Topic

- [Charging the battery](#)
- [Resetting to the factory settings](#)
- [Formatting memory](#)
- [Supported formats](#)
- [Notes for transferring content from your computer](#)

[Notes on use](#)

4-529-726-11(1)

Copyright 2014 Sony Corporation



Digital Music Player
NWZ-B183/B183F

Songs are not played back in the expected order.

- If songs are being played back using shuffle, cancel shuffle to return to normal playback.

Related Topic

● [Shuffle playback](#)

[Notes on use](#)

4-529-726-11(1)

Copyright 2014 Sony Corporation



[□] is displayed in the screen.

- Some types of characters and symbols may not be displayed correctly on your Walkman in the following cases:
 - A language which is not supported by the Walkman is used in the text.
 - User-defined characters or special symbols are used in the text.
- Replace the undisplayable characters with displayable ones using the software that you used to transfer the content such as music on your computer. Then check that the characters are displayed correctly.

[Notes on use](#)

4-529-726-11(1)

Copyright 2014 Sony Corporation

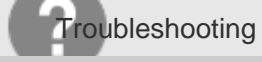

Digital Music Player
NWZ-B183/B183F

[Unknown] is displayed for the album name or artist name.

- Information such as album or artist name is not included in the data. You can add the album or artist name to the content such as music transferred using software (Media Go, iTunes, etc.).

[Notes on use](#)

4-529-726-11(1)

Copyright 2014 Sony Corporation



Digital Music Player
NWZ-B183/B183F

Cannot delete content such as music using the Walkman functions.

- You cannot delete the sample data installed at the factory on your Walkman. Also, you cannot delete the content transferred using software such as Media Go or iTunes on the Walkman. Delete them using the software that you used to transfer them.
- You cannot delete content transferred using Windows Explorer on your Walkman. Delete the content using Windows Explorer.

Related Topic

- [Deleting content from your Walkman using Explorer](#)

[Notes on use](#)

4-529-726-11(1)

Copyright 2014 Sony Corporation



Digital Music Player
NWZ-B183/B183F

The remaining recording time remains the same even though files are deleted.

- Due to system restrictions, the remaining recording time may not increase if only short files are deleted.

[Notes on use](#)

4-529-726-11(1)

Copyright 2014 Sony Corporation



Digital Music Player
NWZ-B183/B183F

Cannot record.

- If there is not enough free space in the built-in flash memory, delete unnecessary files or export recorded files to a computer. Necessary free space may vary, depending on the bit rate or recording time.
- If the maximum number of files that can be recorded is reached, delete unnecessary files or export the recorded files to a computer. For information on the maximum number of recordable files and folders, see the related topic.
- If your Walkman is connected to a computer, disconnect it from the computer.

[Notes on use](#)

4-529-726-11(1)

Copyright 2014 Sony Corporation



Digital Music Player
NWZ-B183/B183F

The combined total elapsed and remaining recording time does not equal the maximum recording time.

- Due to system restrictions, remaining recording time may decrease by a few seconds when you start recording.

[Notes on use](#)

4-529-726-11(1)

Copyright 2014 Sony Corporation



Digital Music Player
NWZ-B183/B183F

A folder is not deleted even though all recorded files have been deleted.

- Files other than recorded files are included in the folder. Open the folder using Windows Explorer or the Mac Finder, and delete all files other than those recorded by your Walkman.

[Notes on use](#)

4-529-726-11(1)

Copyright 2014 Sony Corporation

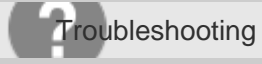

Digital Music Player
NWZ-B183/B183F

Cannot hear FM radio broadcasts.

- The headphone cord functions as an antenna. FM broadcasts cannot be received when the headphones are not connected.
- The received station may not be fully tuned in. Fully tune in to a station for the best reception.

Related Topic

● [FM radio operations](#)

[Notes on use](#)

4-529-726-11(1)

Copyright 2014 Sony Corporation



There is a lot of noise in the FM radio broadcast and the sound quality is poor.

- The FM signal may be weak inside a building or vehicle. Listen to the FM broadcast near a window if the signal is weak inside a building or vehicle.
- The headphone cord functions as an antenna. Extend the headphone cord as far as possible.
- When using a device that emits radio signals such as a mobile phone, keep it away from your Walkman.

[Notes on use](#)

4-529-726-11(1)

Copyright 2014 Sony Corporation



Digital Music Player
NWZ-B183/B183F

Your Walkman gets warm.

- Depending on the way to use your Walkman, the Walkman may become warm while the battery is being charged or an application is in use. This is not a malfunction.

[Notes on use](#)

4-529-726-11(1)

Copyright 2014 Sony Corporation